



VIGOUR PACK

VG WEBSITE



BUT-N-LOC[®]

 PATENTED BUTTON LOCK DESIGN

TAMPER EVIDENT CONTAINER SERIES

- ✓ Original innovators of the button lock design
- ✓ Available in RPET, Blended PET or PET
- ✓ High clarity and tight lid fit prevents leakage

www.vigourpack.com

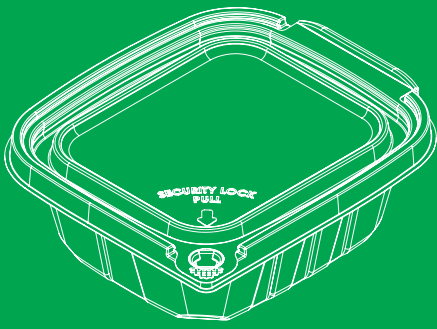

HINGED LID TYPE

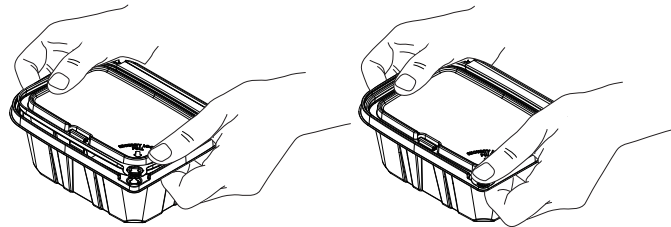

CLOSE THE LID

PUSH TO "LOC" BUTTON

CLOSE & OPEN

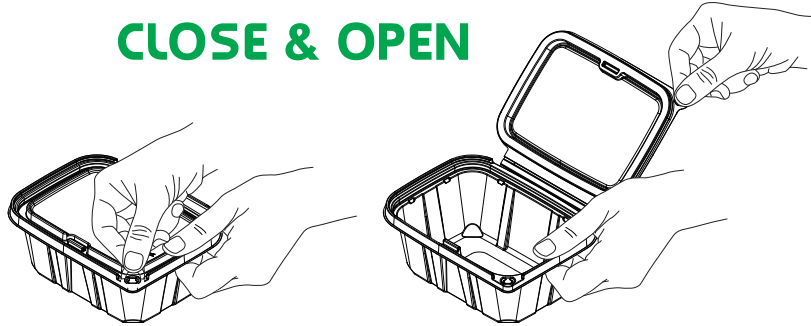

PULL THE TAB, BUTTON REMAINS

OPEN THE LID

 PATENTED BUTTON LOCK DESIGN

BUT-N-LOC®

The innovative tamper-resistant locking mechanism and seal ensures quality and eliminates the need for shrink bands and wrap labels.



LOCKED

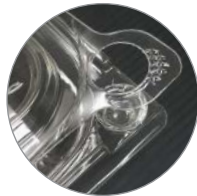

OPENED



NO LEAK LID

The button "Loc" tab fastens to the top of the base. If tampered with prior to purchase the **BUT-N-LOC®** button will not be connected to the tab and a clean hole in the tab will be evident. The engineered tight parameter seal promises a leak resistant experience.

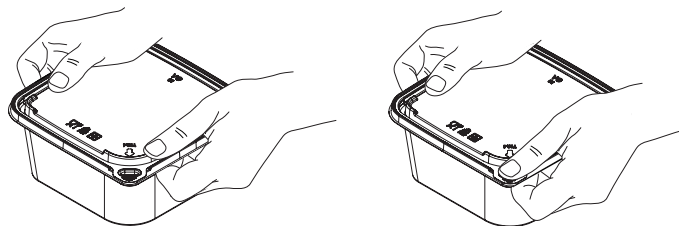

CLOSE THE LID

PUSH TO "LOC" BUTTON

CLOSE & OPEN

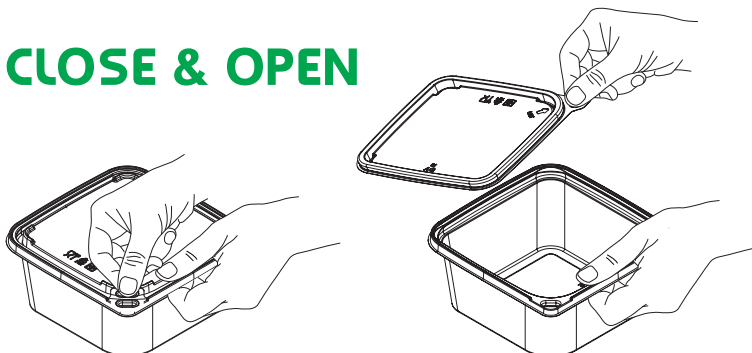

PULL THE TAB, BUTTON REMAINS

OPEN THE LID

2 PIECES TYPE

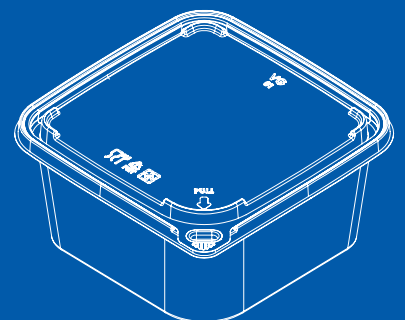



**BUT-N-LOC. TAMPER EVIDENT
HINGED LID CONTAINERS**

These patented hinged containers provides superior security and enhances the look of product with their crystal clear clarity. Perfect for cold pasta, fruit salad, leafy green salad, nuts, snack mixes, candy, desserts, and more. Ideal for delis, supermarkets, C-stores, and wholesale clubs.

It can be made from post-consumer recycled PET (rPET), provide environmental benefits and meet customer demand for more sustainable food packaging.



4oz

RPTTE4AD
110 x 90 x 32
780 PCS / CTN.
CTN. SIZE (mm)
560 x 465 x 419
3.85 CU.FT.
0.11 CBM
8.7 KG / 19.1 LBS



6oz

RPTTE6AD
110 x 90 x 44
780 PCS / CTN.
CTN. SIZE (mm)
565 x 465 x 431
4.00 CU.FT.
0.11 CBM
11.0 KG / 24.3 LBS



8oz

RPTTE8-R
147 x 128 x 39
240 PCS / CTN.
CTN. SIZE (mm)
527 x 314 x 329
1.92 CU.FT.
0.05 CBM
5.0 KG / 10.9 LBS



12oz

RPTTE12-R
147 x 128 x 51
240 PCS / CTN.
CTN. SIZE (mm)
527 x 314 x 342
2.00 CU.FT.
0.06 CBM
5.2 KG / 11.5 LBS



16oz

RPTTE16-R
147 x 128 x 65
240 PCS / CTN.
CTN. SIZE (mm)
527 x 314 x 356
2.08 CU.FT.
0.06 CBM
6.2 KG / 13.7 LBS

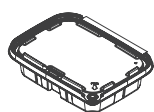

20oz

RPTTE20N-R
189 x 145 x 46
200 PCS / CTN.
CTN. SIZE (mm)
380 x 312 x 516
2.16 CU.FT.
0.06 CBM
7.3 KG / 16.2 LBS

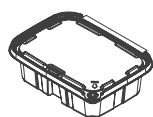

24oz

RPTTE24-R
189 x 145 x 57
200 PCS / CTN.
CTN. SIZE (mm)
380 x 312 x 528
2.21 CU.FT.
0.06 CBM
8.0 KG / 17.7 LBS



32oz

RPTTE32-R
189 x 146 x 70
200 PCS / CTN.
CTN. SIZE (mm)
380 x 312 x 540
2.26 CU.FT.
0.06 CBM
8.6 KG / 19.0 LBS

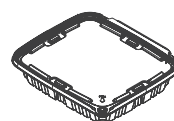

35oz

RPTTE35
223 x 201 x 46
134 PCS / CTN.
CTN. SIZE (mm)
455 x 425 x 455
3.11 CU.FT.
0.09 CBM
8.4 KG / 18.6 LBS



35oz SMOOTH WALL

RPTTE35SW-R
223 x 201 x 46
150 PCS / CTN.
CTN. SIZE (mm)
442 x 375 x 465
2.72 CU.FT.
0.08 CBM
9.3 KG / 20.5 LBS

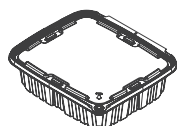

48oz

RPTTE48N
223 x 201 x 60
134 PCS / CTN.
CTN. SIZE (mm)
455 x 425 x 470
3.21 CU.FT.
0.09 CBM
9.0 KG / 19.8 LBS

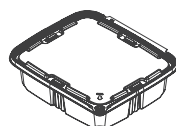

48oz SMOOTH WALL

RPTTE48SW-R
223 x 201 x 60
150 PCS / CTN.
CTN. SIZE (mm)
425 x 400 x 475
2.85 CU.FT.
0.08 CBM
9.9 KG / 21.9 LBS

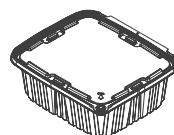

64oz

RPTTE64N
223 x 201 x 77
134 PCS / CTN.
CTN. SIZE (mm)
475 x 425 x 470
3.35 CU.FT.
0.09 CBM
10.5 KG / 23.1 LBS

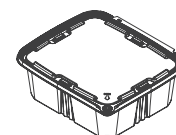

64oz SMOOTH WALL

RPTTE64SW-R
223 x 201 x 77
150 PCS / CTN.
CTN. SIZE (mm)
425 x 425 x 475
3.03 CU.FT.
0.09 CBM
11.6 KG / 25.6 LBS



**TAMPER EVIDENT
TEAR OFF STRIP HINGED CONTAINERS**

Tear strip locks provide protection to ensure that the container has not been opened since the product was packaged.

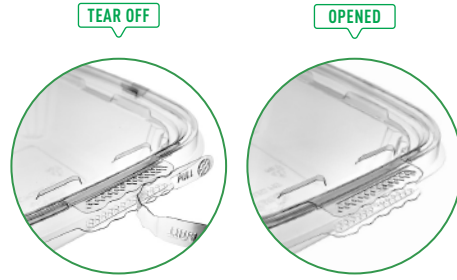

8oz

T08

147 x 128 x 39
240 PCS / CTN.
CTN. SIZE (mm)
527 x 314 x 330
1.93 CU.FT.
0.05 CBM
4.8 KG / 10.7 LBS



12oz

T012

147 x 128 x 51
240 PCS / CTN.
CTN. SIZE (mm)
527 x 314 x 342
2.00 CU.FT.
0.06 CBM
5.2 KG / 11.5 LBS



16oz

T016

147 x 128 x 65
240 PCS / CTN.
CTN. SIZE (mm)
527 x 314 x 356
2.08 CU.FT.
0.06 CBM
6.2 KG / 13.7 LBS



20oz

T020

189 x 145 x 46
200 PCS / CTN.
CTN. SIZE (mm)
380 x 314 x 516
2.17 CU.FT.
0.06 CBM
7.4 KG / 16.2 LBS

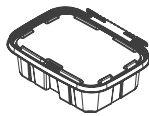

24oz

T024

189 x 143 x 57
200 PCS / CTN.
CTN. SIZE (mm)
380 x 312 x 528
2.21 CU.FT.
0.06 CBM
8.0 KG / 17.7 LBS

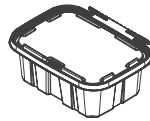

32oz

T032

189 x 146 x 70
200 PCS / CTN.
CTN. SIZE (mm)
380 x 312 x 540
2.26 CU.FT.
0.06 CBM
8.4 KG / 18.6 LBS

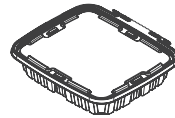

35oz

T035

223 x 201 x 44
180 PCS / CTN.
CTN. SIZE (mm)
455 x 425 x 455
3.11 CU.FT.
0.09 CBM
11.0 KG / 24.2 LBS



35oz SMOOTH WALL

T035SW

223 x 201 x 44
180 PCS / CTN.
CTN. SIZE (mm)
455 x 425 x 455
3.11 CU.FT.
0.09 CBM
11.0 KG / 24.2 LBS

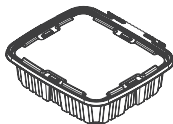

48oz

T048

223 x 201 x 60
176 PCS / CTN.
CTN. SIZE (mm)
455 x 425 x 470
3.21 CU.FT.
0.09 CBM
11.5 KG / 25.3 LBS

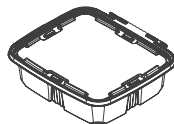

48oz SMOOTH WALL

T048SW

223 x 201 x 60
176 PCS / CTN.
CTN. SIZE (mm)
455 x 425 x 470
3.21 CU.FT.
0.09 CBM
11.5 KG / 25.3 LBS

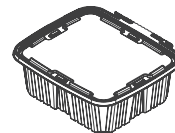

64oz

T064

223 x 201 x 77
164 PCS / CTN.
CTN. SIZE (mm)
475 x 425 x 470
3.35 CU.FT.
0.09 CBM
12.6 KG / 27.8 LBS

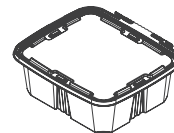

64oz SMOOTH WALL

T064SW

223 x 201 x 77
164 PCS / CTN.
CTN. SIZE (mm)
475 x 425 x 470
3.35 CU.FT.
0.09 CBM
12.6 KG / 27.8 LBS



TAMPER EVIDENT TEAR OFF STRIP SQUARE CONTAINERS



8oz

TOSQ408

128 x 120 x 40

540 PCS / CTN.

CTN. SIZE (mm)

527 x 375 x 363

3.93 CU.FT.

0.11 CBM

11.3 KG / 24.8 LBS



12oz

TOSQ412

128 x 120 x 54

414 PCS / CTN.

CTN. SIZE (mm)

527 x 375 x 460

3.21 CU.FT.

0.09 CBM

11.5 KG / 23.2 LBS



16oz

TOSQ416

128 x 120 x 75

390 PCS / CTN.

CTN. SIZE (mm)

527 x 375 x 458

3.20 CU.FT.

0.09 CBM

12.3 KG / 27.1 LBS



24oz

TOSQ424

128 x 120 x 100

360 PCS / CTN.

CTN. SIZE (mm)

527 x 375 x 455

3.18 CU.FT.

0.09 CBM

15.4 KG / 34.0 LBS



32oz

TOSQ432

128 x 120 x 129

300 PCS / CTN.

CTN. SIZE (mm)

527 x 375 x 428

2.99 CU.FT.

0.08 CBM

15.1 KG / 33.3 LBS



BUT-N-LOC. TAMPER EVIDENT 2, 3, 4-COMPARTMENT CONTAINERS

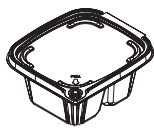

16oz 2 comp.
RPTTE16-2C
147 x 128 x 65
240 PCS / CTN.
CTN. SIZE (mm)
600 x 390 x 280
2.31 CU.FT.
0.07 CBM
6.9 KG / 15.2 LBS

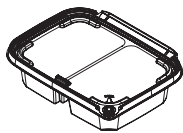

20oz 2 comp.
RPTTE20-2C
189 x 145 x 46
200 PCS / CTN.
CTN. SIZE (mm)
605 x 395 x 325
2.74 CU.FT.
0.08 CBM
8.0 KG / 17.7 LBS

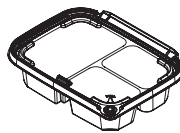

20oz 3 comp.
RPTTE20-3C
189 x 145 x 46
200 PCS / CTN.
CTN. SIZE (mm)
605 x 395 x 325
2.74 CU.FT.
0.08 CBM
8.0 KG / 17.7 LBS

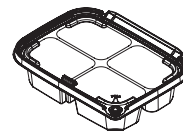

20oz 4 comp.
RPTTE20-4C
189 x 145 x 46
200 PCS / CTN.
CTN. SIZE (mm)
605 x 395 x 325
2.74 CU.FT.
0.08 CBM
8.0 KG / 17.7 LBS



**BUT-N-LOC. TAMPER EVIDENT
SQUARE DELI CONTAINERS**

These patented clear containers are available in five base sizes: 8, 12, 16, 24 & 32oz with one common lid fit for all sizes. A recessed lid allows for stable stacking to maximize shelf space. Available in bulk and combo (base+lid) packs.

Perfect for cold, ready-to-eat foods, like: pasta salad, cut fruit, nuts and candy. Ideal for delis, C-stores, supermarkets, and wholesale clubs.

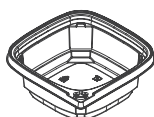

8oz 260ml

PTTESDC08
121 x 121 x 45
500 PCS / CTN.
CTN. SIZE (mm)
625 x 265 x 330
1.93 CU.FT.
0.05 CBM
7.0 KG / 15.5 LBS

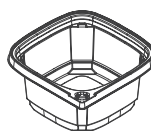

12oz 360ml

PTTESDC12
121 x 121 x 59
500 PCS / CTN.
CTN. SIZE (mm)
625 x 265 x 360
2.10 CU.FT.
0.06 CBM
9.1 KG / 20.1 LBS

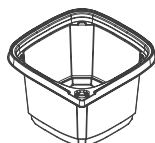

16oz 530ml

PTTESDC16
121 x 121 x 78
500 PCS / CTN.
CTN. SIZE (mm)
625 x 265 x 380
2.22 CU.FT.
0.06 CBM
10.9 KG / 23.9 LBS

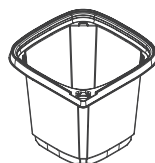

24oz 710ml

PTTESDC24
121 x 121 x 102
500 PCS / CTN.
CTN. SIZE (mm)
625 x 265 x 430
2.51 CU.FT.
0.07 CBM
12.9 KG / 28.4 LBS

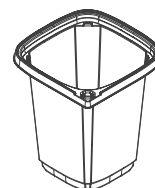

32oz 910ml

PTTESDC32
121 x 121 x 133
500 PCS / CTN.
CTN. SIZE (mm)
625 x 265 x 500
2.92 CU.FT.
0.08 CBM
16.9 KG / 37.4 LBS

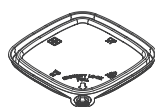

**LID
(8-32oz)**

PTTESDCLID
116 x 116 x 7
500 PCS / CTN.
CTN. SIZE (mm)
580 x 250 x 290
1.48 CU.FT.
0.04 CBM
5.0 KG / 11.1 LBS

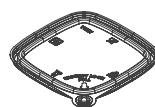

**LID VENTED
(8-32oz)**

PTTESDCLID-V
116 x 116 x 7
500 PCS / CTN.
CTN. SIZE (mm)
580 x 250 x 290
1.48 CU.FT.
0.04 CBM
5.0 KG / 11.1 LBS

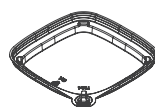

**LID RECESSED
(8-32oz)**

PTTESDCLID
116 x 116 x 7
500 PCS / CTN.
CTN. SIZE (mm)
580 x 250 x 295
1.51 CU.FT.
0.04 CBM
5.0 KG / 11.1 LBS



BUT-N-LOC. TAMPER EVIDENT 7x6" HINGED LID CONTAINERS

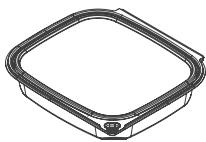

16oz

RPTTE76-16
181 x 163 x 34
348 PCS / CTN.
CTN. SIZE (mm)
557 x 340 x 576
3.85 CU.FT.
0.11 CBM
11.7 KG / 25.8 LBS

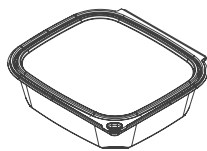

24oz

RPTTE76-24H
181 x 163 x 47
339 PCS / CTN.
CTN. SIZE (mm)
557 x 340 x 576
3.85 CU.FT.
0.11 CBM
13.7 KG / 30.2 LBS

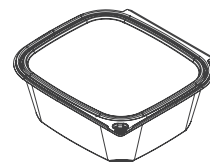

32oz

RPTTE76-32H
181 x 163 x 66
315 PCS / CTN.
CTN. SIZE (mm)
557 x 340 x 580
3.88 CU.FT.
0.11 CBM
14.4 KG / 31.7 LBS



BUT-N-LOC. TAMPER EVIDENT DOME LID 4 CELL CONTAINER

With 4 cell easily separate different foods and ensure that flavors don't mix.

Hinge design ensures the base and lid remain attached and the dome lid provides more capacity.

Great choice for carrying a variety of foods. Ideal for delis, C-stores, supermarkets, and wholesale clubs.

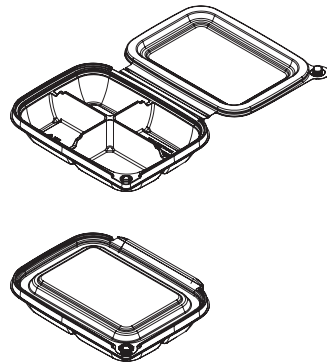

16oz

RPTTE16SP4C

189 x 143 x 38

460 PCS / CTN.

CTN. SIZE (mm)

609 x 392 x 604

5.09 CU.FT.

0.14 CBM

17.5 KG / 38.5 LBS



BUT-N-LOC. TAMPER EVIDENT HINGED SANDWICH WEDGE

VG's patented **But-N-Loc**® tamper evident hinged sandwich wedge is ideal for any sandwich shop, café, deli, or canteen.

The high-clarity material and contoured design ensures superb product visibility and attractive presentation for ready-made sandwich.

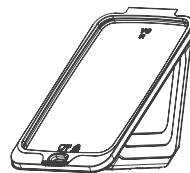

RPTTESW
142 x 101 x 129
250 PCS / CTN.
CTN. SIZE (mm)
525 x 395 x 360
2.64 CU.FT.
0.07 CBM
7.2 KG / 15.9 LBS



BUT-N-LOC. TAMPER EVIDENT TRAY 9x13" 7 CELL

This 7 compartment container is perfect for leaf or pasta salads, cut vegetables, cut fruit, nuts, candies and other specialty foods.

Tight lid fit eliminates leakage, extends shelf life and product freshness and sturdy design allows stacking and bulk display in store.

Lid design ensure various food products remain separate in sealed compartments.

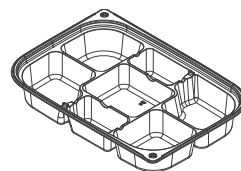

PTTE913-7C
 350 x 270 x 55
 100 PCS / CTN.
 CTN. SIZE (mm)
 518 x 365 x 455
 3.04 CU.FT. / 0.09 CBM
 7.6 KG / 16.7 LBS

VENTED LID

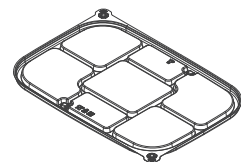

PTTE913-7CLID-V
 350 x 270 x 10
 100 PCS / CTN.
 CTN. SIZE (mm)
 503 x 365 x 420
 2.72 CU.FT. / 0.08 CBM
 7.3 KG / 16.1 LBS



BUT-N-LOC

**TAMPER EVIDENT
SQUARE BOWLS**



These patented clear square bowls are perfect for leaf or pasta salads, cut vegetables, cut fruit, nuts, candies and other specialty foods. Ideal for delis, supermarkets, wholesale clubs, and C-stores. Crystal clear lids give the consumer a clear view before buying and they are also crack-resistant and spill-proof to ensure safe and stable handling. Black base available in custom option.

5.0" 127mm Dia.

Available in three ranges - 5" (small), 7.5" (Medium), and 9" (Large) in a variety of sizes and single, or 4 compartment options. The stack-ability of these square bowl may improve your shelf space utilization.



8oz

PTTESB5-08B
127 x 127 x 41
600 PCS / CTN.
CTN. SIZE (mm)
525 x 395 x 395
2.89 CU.FT.
0.08 CBM
7.3 KG / 16.1 LBS



12oz

PTTESB5-12B
127 x 127 x 56
600 PCS / CTN.
CTN. SIZE (mm)
525 x 395 x 400
2.93 CU.FT.
0.08 CBM
7.9 KG / 17.4 LBS

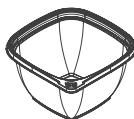

16oz

PTTESB5-16B
127 x 127 x 73
600 PCS / CTN.
CTN. SIZE (mm)
525 x 395 x 410
3.00 CU.FT.
0.08 CBM
9.1 KG / 20.1 LBS



FLAT LID

PTTESBFLID5B
127 x 127 x 8
600 PCS / CTN.
CTN. SIZE (mm)
495 x 375 x 350
2.29 CU.FT.
0.06 CBM
6.9 KG / 15.2 LBS

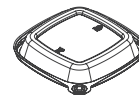

DOME LID

PTTESBDLD5B
127 x 127 x 21
600 PCS / CTN.
CTN. SIZE (mm)
495 x 375 x 340
2.23 CU.FT.
0.06 CBM
6.9 KG / 15.1 LBS

7.5"
191mm Dia.

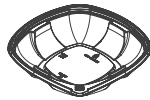

18oz
PTTESB75-18B
191 x 191 x 39
300 PCS / CTN.
CTN. SIZE (mm)
600 x 405 x 360
3.09 CU.FT. / .09 CBM
7.1 KG / 15.5 LBS

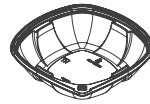

24oz
PTTESB75-24B
191 x 191 x 49
300 PCS / CTN.
CTN. SIZE (mm)
600 x 405 x 390
3.35 CU.FT. / 0.09 CBM
7.7 KG / 17.0 LBS

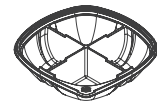

24oz 4 comp.
PTTESB75-24B-4C
191 x 191 x 49
300 PCS / CTN.
CTN. SIZE (mm)
600 x 405 x 390
3.35 CU.FT. / 0.09 CBM
7.7 KG / 17.0 LBS



32oz
PTTESB75-32B
191 x 191 x 62
300 PCS / CTN.
CTN. SIZE (mm)
600 x 405 x 400
3.43 CU.FT. / 0.10 CBM
8.0 KG / 17.7 LBS



48oz
PTTESB75-48B
191 x 191 x 86
300 PCS / CTN.
CTN. SIZE (mm)
600 x 405 x 435
3.73 CU.FT. / 0.11 CBM
9.0 KG / 19.8 LBS

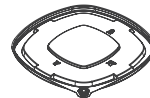

(18-48oz)
PTTESBFLID75B
191 x 191 x 10
300 PCS / CTN.
CTN. SIZE (mm)
565 x 385 x 355
2.73 CU.FT. / 0.08 CBM
6.4 KG / 14.0 LBS

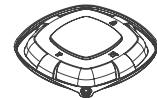

(18-48oz)
PTTESBDLID75B
191 x 191 x 24
300 PCS / CTN.
CTN. SIZE (mm)
565 x 385 x 350
2.69 CU.FT. / 0.08 CBM
6.4 KG / 14.0 LBS

9.0"
229mm Dia.

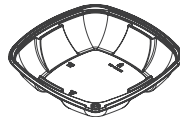

40oz
PTTESB9-40B
229 x 229 x 51
180 PCS / CTN.
CTN. SIZE (mm)
480 x 250 x 470
1.99 CU.FT. / 0.06 CBM
6.5 KG / 14.3 LBS

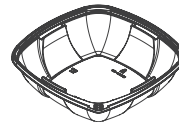

48oz
PTTESB9-48B
229 x 229 x 61
180 PCS / CTN.
CTN. SIZE (mm)
480 x 250 x 565
2.39 CU.FT. / 0.07 CBM
6.6 KG / 14.5 LBS



48oz 4 comp.
PTTESB9-48B-4C
229 x 229 x 61
180 PCS / CTN.
CTN. SIZE (mm)
480 x 250 x 565
2.39 CU.FT. / 0.07 CBM
6.6 KG / 14.5 LBS

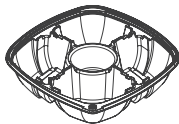

48oz 5 comp.
PTTESB9-48B-5C
229 x 229 x 57
180 PCS / CTN.
CTN. SIZE (mm)
480 x 250 x 563
2.38 CU.FT. / 0.07 CBM
7.1 KG / 15.7 LBS

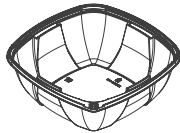

64oz
PTTESB9-64B
229 x 229 x 79
180 PCS / CTN.
CTN. SIZE (mm)
480 x 250 x 590
2.50 CU.FT. / 0.07 CBM
7.7 KG / 17.0 LBS

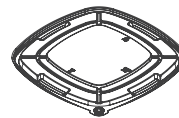

(40-64oz)
PTTESBFLID9B
218 x 218 x 11
180 PCS / CTN.
CTN. SIZE (mm)
480 x 250 x 475
2.01 CU.FT. / 0.06 CBM
6.0 KG / 13.1 LBS

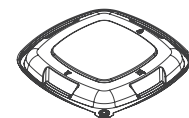

(40-64oz)
PTTESBDLID9B
218 x 218 x 35
180 PCS / CTN.
CTN. SIZE (mm)
480 x 250 x 455
1.93 CU.FT. / 0.05 CBM
5.9 KG / 13.0 LBS



**BUT-N-LOC[®] TAMPER EVIDENT
HINGED LID ROUND BOWL**

Perfect for leaf or pasta salads, cut vegetables, cut fruit, nuts, candies and other specialty foods.



8oz

RPTTERBS08
153 x 149 x 52
352 PCS / CTN.
CTN. SIZE (mm)
611 x 316 x 459
3.13 CU.FT.
0.09 CBM
7.7 KG / 17.0 LBS

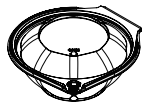

12oz

RPTTERBS12
153 x 149 x 65
340 PCS / CTN.
CTN. SIZE (mm)
611 x 316 x 459
3.12 CU.FT.
0.09 CBM
8.1 KG / 18.0 LBS

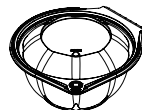

16oz

RPTTERBS16
153 x 149 x 78
332 PCS / CTN.
CTN. SIZE (mm)
611 x 316 x 462
3.15 CU.FT.
0.09 CBM
8.6 KG / 19.0 LBS

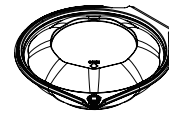

18oz

RPTTERBM18
182 x 178 x 61
375 PCS / CTN.
CTN. SIZE (mm)
626 x 374 x 559
4.62 CU.FT.
0.13 CBM
14.5 KG / 32.0 LBS

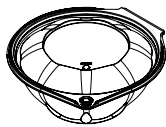

24oz

RPTTERBM24
182 x 178 x 75
300 PCS / CTN.
CTN. SIZE (mm)
531 x 374 x 559
3.92 CU.FT.
0.11 CBM
12.4 KG / 27.3 LBS

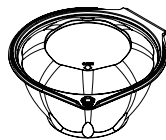

32oz

RPTTERBM32
182 x 178 x 97
345 PCS / CTN.
CTN. SIZE (mm)
614 x 374 x 559
4.53 CU.FT.
0.13 CBM
14.6 KG / 32.3 LBS

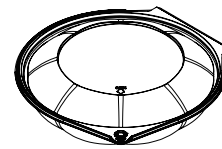

48oz

RPTTERBL48
246 x 244 x 72
88 PCS / CTN.
CTN. SIZE (mm)
499 x 351 x 516
3.19 CU.FT.
0.09 CBM
7.6 KG / 16.7 LBS



**BUT-N-LOC. TAMPER EVIDENT
FLAT PANEL PARFAIT CUPS**

These cups are suitable for cut fruit, cut veggies, cookies, biscuits, yogurt parfaits and other snacks.

Fits into the center console cup holders of most cars. Besides, the flat panel design makes it easy to apply a label and have it lay flat.



9oz 278ml
RPTTEFPC-09
111 x 100 x 72
500 PCS / CTN.
CTN. SIZE (mm)
580 x 425 x 385
3.35 CU.FT.
0.09 CBM
11.2 KG / 24.7 LBS



11oz 335ml
RPTTEFPC-11
111 x 100 x 88
500 PCS / CTN.
CTN. SIZE (mm)
580 x 425 x 410
3.57 CU.FT.
0.10 CBM
12.9 KG / 28.4 LBS



13oz 400ml
RPTTEFPC-13
111 x 100 x 108
450 PCS / CTN.
CTN. SIZE (mm)
580 x 425 x 400
3.48 CU.FT.
0.10 CBM
9.8 KG / 21.6 LBS

VENTED



9oz 278ml
RPTTEFPC-09V
111 x 100 x 72
500 PCS / CTN.
CTN. SIZE (mm)
580 x 425 x 385
3.35 CU.FT.
0.09 CBM
11.2 KG / 24.7 LBS

VENTED



11oz 335ml
RPTTEFPC-11V
111 x 100 x 88
500 PCS / CTN.
CTN. SIZE (mm)
580 x 425 x 410
3.57 CU.FT.
0.10 CBM
12.9 KG / 28.4 LBS

VENTED



13oz 400ml
RPTTEFPC-13V
111 x 100 x 108
450 PCS / CTN.
CTN. SIZE (mm)
580 x 425 x 400
3.48 CU.FT.
0.10 CBM
9.8 KG / 21.6 LBS

DOME LID



13oz
RPTTEFPC-D13
111 x 100 x 139
450 PCS / CTN.
CTN. SIZE (mm)
580 x 425 x 400
3.48 CU.FT.
0.10 CBM
11.0 KG / 24.2 LBS

INSERT



4oz 120ml
RPTTEFPC-IN
94 x 81 x 36
1,200 PCS / CTN.
CTN. SIZE (mm)
501 x 391 x 315
2.18 CU.FT.
0.06 CBM
6.4 KG / 14.0 LBS

INSERT 2C



4oz 110ml
RPTTEFPC-IN2
94 x 81 x 36
1,200 PCS / CTN.
CTN. SIZE (mm)
501 x 391 x 315
2.18 CU.FT.
0.06 CBM
7.6 KG / 16.7 LBS

SPECIALIZED EQUIPMENT



DESIGNED FOR
VG TAMPER EVIDENT
HINGED LID CONTAINERS

CLOSING MACHINE



IDEAL DESIGN FOR
FRESH PRODUCE
PACKAGING



ACCELERATES
AND SIMPLIFIES
CLOSING PROCESS



COMPACT, EASY TO USE,
CLEAN AND MAINTAIN

VPA200-1

1975 x 998 x 1055 (mm)

77.8 x 39.3 x 41.5 (in)

150kg (330.7 lbs)

CTN. SIZE (mm) 2180 x 1200 x 1390
CTN. G.W. 250 KG / 551.2 LBS

VG automatic closing machine is designed specifically for our patented **BUT-N-LOC** tamper evident hinged lid containers, operates with sizes 8oz to 64oz, and processes up to 80 containers per minute. Sturdy aluminum and steel construction with electronic control system for flexible ease of use operation.

Our machine increases productivity through reduced labour costs, improved reliability and output. Ideal secure packaging system for a wide variety of fresh food products, VG automatic closing machines are as efficient as they are effective.



VIGOUR PACK

FULL LINE DISPOSABLE PACKAGING SOLUTIONS TO MEET THE EVOLVING DEMANDS

www.vigourpack.com