



INNOVATIVE BEVERAGE & FOOD  
DISPOSABLE PACKAGING SOLUTIONS  
FOR EVERY OCCASION

# PRODUCT CATALOGUE



VIGOUR GROUP

[www.vigourpack.com](http://www.vigourpack.com)



Founded in 2002, VIGOUR GROUP is one of the leading disposable paper and plastic packaging manufacturers in Taiwan.

We focus on providing high quality, competitively priced paper and plastic foodservice disposables to the following market segments: C-stores, QSR, supermarkets, food processors, entertainment, airlines.

## GLOBAL SERVICE

We cooperate with key customers in USA, Australia, Europe, Middle East, Asia, Latin America, and over twenty other countries, which has given us an important global footprint.



VIGOUR PACK and VIGOUR PLASTIC are both under the umbrella of its parent holding company of VIGOUR GROUP.



Readily available materials include PET, PP, RPET, PLA, PBS, and paper boards, all of which are 100% FDA certified for food contact.



We provide convenient and efficient air, land and shipping routes. We are committed to give the best service and sales experience, no matter where you are located.

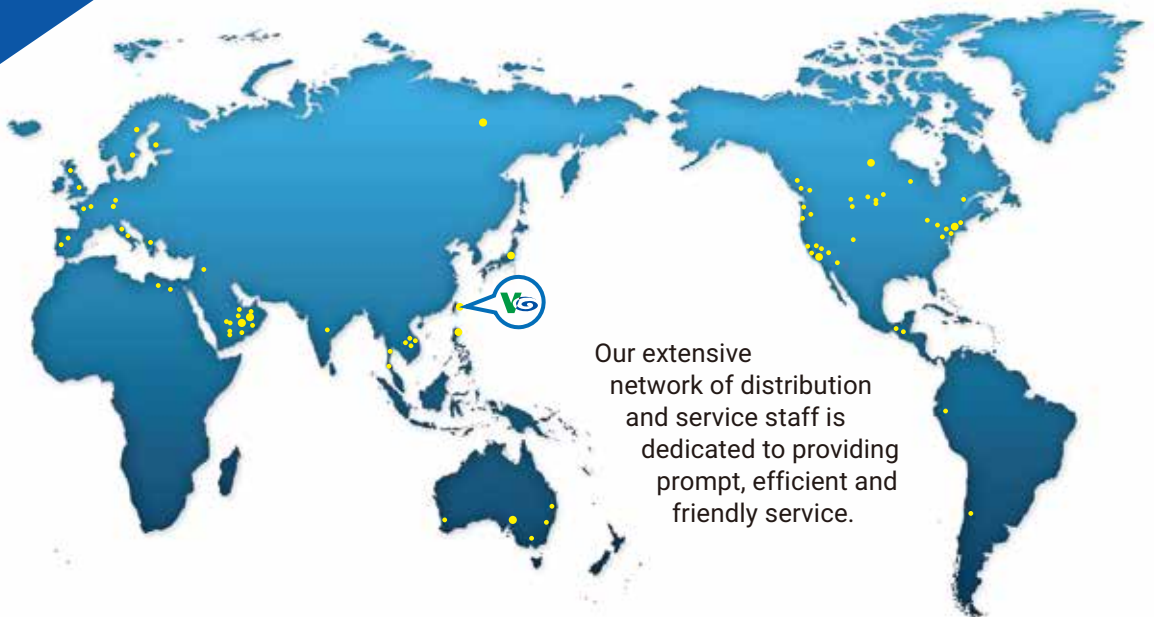

Our extensive network of distribution and service staff is dedicated to providing prompt, efficient and friendly service.

# CERTIFICATION & CAPABILITIES

FSSC22000 Certifications make us Global Food Safety Initiative (GFSI) certified.

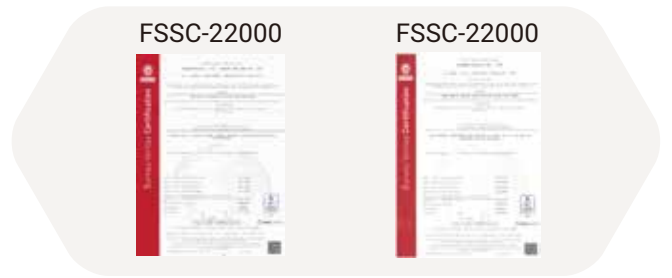

## PLANT FACILITY

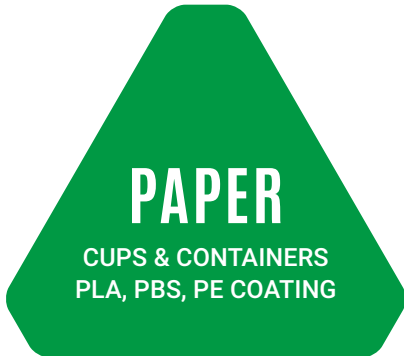

**6** sets double wall paper cup forming machines.

**36** German-made fully integrated and automated paper cup/container forming and packing lines.

Finished cups are auto-packed directly into sleeves to prevent any external contact. Film lamination to paper board capacity is over 5,000 tons per month.



**9** EXTRUDERS, the monthly capacity of Eco-friendly material (RPET and PLA) products is over 400 tons each.

**26** HIGH SPEED THERMOFORMERS which produce plastic cups (PET, PLA clear cups) and containers (PET, RPET, PLA, PP). Total capacity up to 200 million pcs per month.

## PRINTING APPLICATION



**5** German Heidelberg offset printing machines that print up to 6-colors and 8-color FLEXO machine for paper cups and containers.



**4** 6-color Van Dam UV offset printing machines for plastic cups and containers.

# INDEX

PAGE NO.

## PET TAMPER EVIDENT CONTAINER SERIES

### BUT-N-LOC SERIES

- 08 HINGED LID CONTAINERS
- 11 7x6"HINGED LID CONTAINERS
- 12 HINGED SANDWICH WEDGE
- HINGED WRAP CONTANER & SMALL CONTAINER
- 13 9X13" 7CELL TRAY
- 14 SQUARE BOWLS
- 17 SQUARE DELI CONTAINERS
- 19 FLAT PANEL PARFAIT CUPS

### TEAR OFF STRIP SERIES

- 22 HINGED LID CONTAINER
- 24 HINGED SQUARE CONTAINER
- 25 HINGED ROUND CONTAINER
- 26 HINGED TEAR OFF PARFAIT CUP

## 27 AUTO CLOSING MACHINE

## PET CONTAINER SERIES

- 28 HINGED TYPE DELI CONTAINER
- 30 HINGED TYPE BAKERY CONTAINERS
- 32 HINGED TYPE BUTTER LETTUCE CONTAINERS
- 33 SINGLE / DOUBLE CLAMSHELL
- 34 4 COMP. SNACK CONTAINER
- 35 ROUND DELI CONTAINERS
- 37 ROUND PRODUCE CONTAINER
- 38 SALAD BOWLS
- 40 CAKE & PIE CONTAINERS

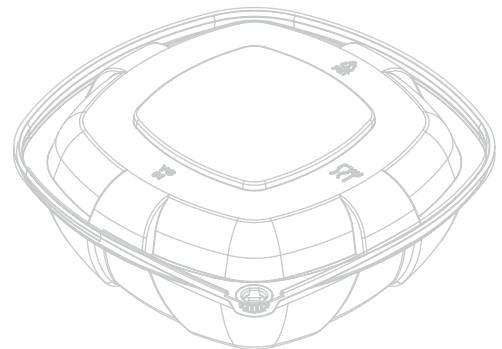
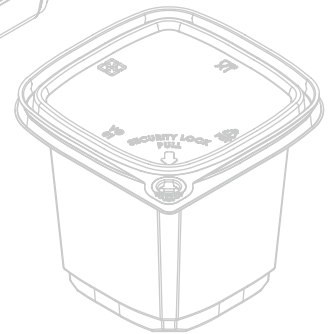
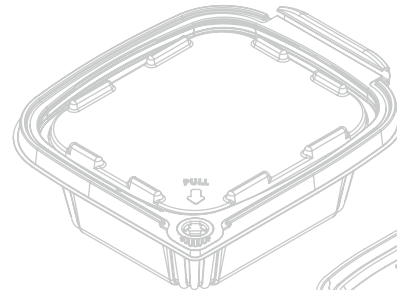
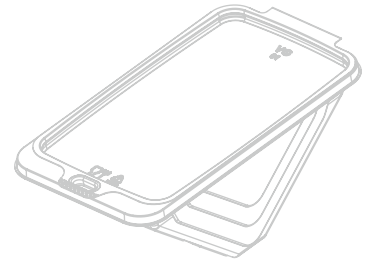



# INDEX

PAGE NO.

<b>42</b>	<b>PET CLEAR CUPS &amp; LIDS</b>
<b>47</b>	<b>PLA BIOPLASTIC CLEAR CUPS &amp; LIDS</b>
<b>51</b>	<b>PLA BIOPLASTIC SALAD BOWL</b>
	<b>PP CONTAINER SERIES</b>
52	HEAVY DUTY PP CONTAINERS
	<b>PAPER CUP SERIES</b>
55	SINGLE WALL PAPER CUPS
57	DOUBLE WALL PAPER CUPS
59	PAPER COLD CUPS
61	DOUBLE-POLY LINED SINGLE WALL PAPER CUPS
62	HOLDERS, SLEEVES, BAGS
	<b>PAPER FOOD CONTAINERS</b>
63	STANDARD PAPER FOOD CONTAINERS
66	HEAVY WEIGHT PAPER FOOD CONTAINERS
68	SQUARE KRAFT PAPER FOOD BOX

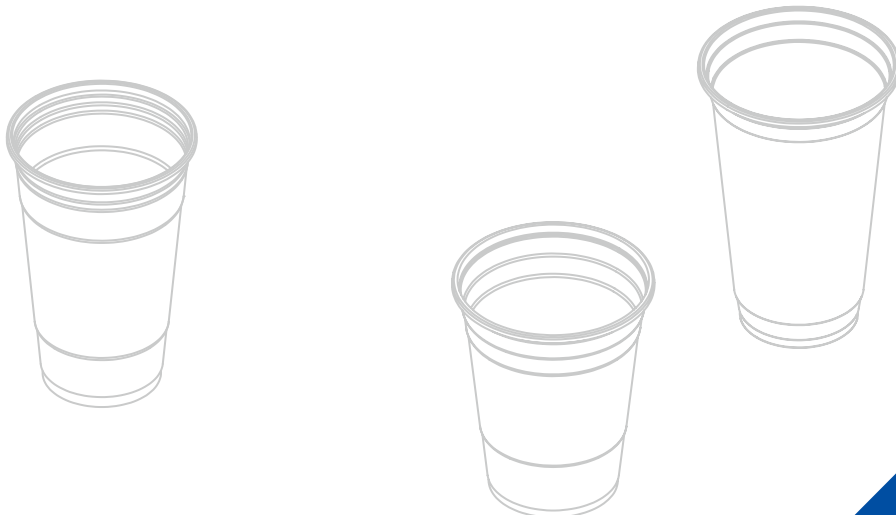

**PERFECT FOR  
WET & DRY  
READY TO EAT  
FOODS**



## **TAMPER EVIDENT CONTAINER SERIES**



- ✔ Available in RPET, Blended PET or PET
- ✔ High clarity and tight lid fit prevents leakage



 PATENTED BUTTON LOCK DESIGN

# BUT-N-LOC<sup>®</sup>

## SERIES

# TEAR OFF

# STRIP

## SERIES



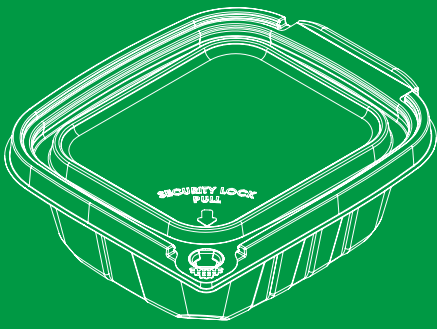

## HINGED LID TYPE

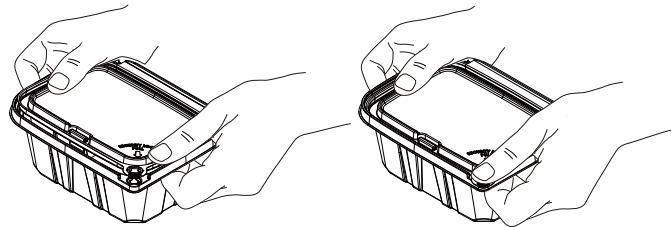

CLOSE THE LID

PUSH TO "LOC" BUTTON

## CLOSE & OPEN

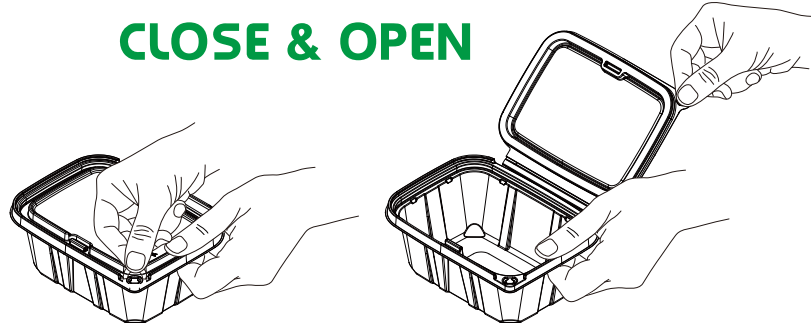

PULL THE TAB, BUTTON REMAINS

OPEN THE LID

 PATENTED BUTTON LOCK DESIGN

# BUT-N-LOC®

The innovative tamper-resistant locking mechanism and seal ensures quality and eliminates the need for shrink bands and wrap labels.

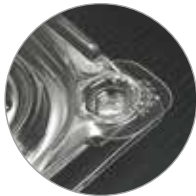

LOCKED



OPENED



NO LEAK LID

The button "Loc" tab fastens to the top of the base. If tampered with prior to purchase the **BUT-N-LOC®** button will not be connected to the tab and a clean hole in the tab will be evident. The engineered tight parameter seal promises a leak resistant experience.

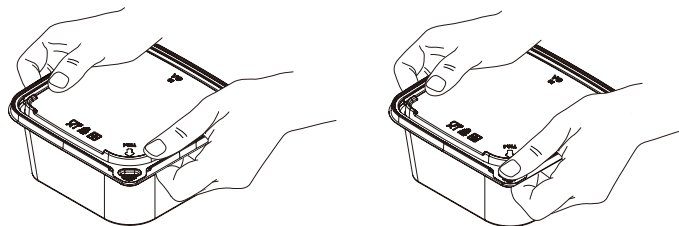

CLOSE THE LID

PUSH TO "LOC" BUTTON

## CLOSE & OPEN

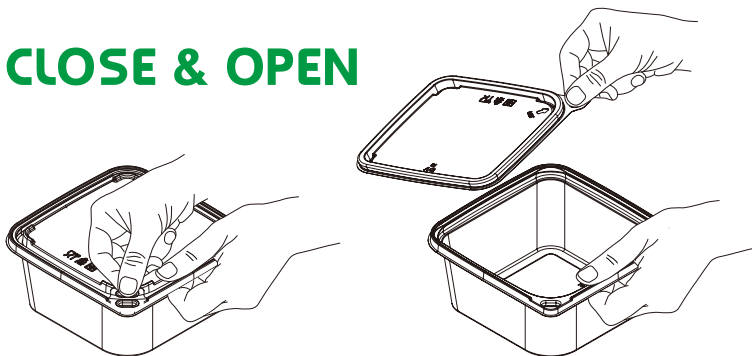

PULL THE TAB, BUTTON REMAINS

OPEN THE LID

## 2 PIECES TYPE

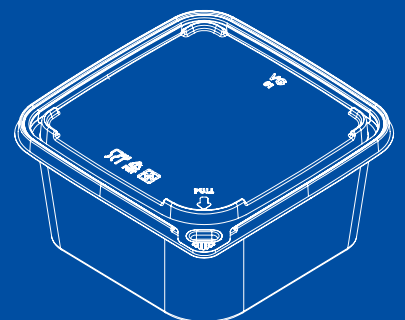



**BUT-N-LOC. TAMPER EVIDENT  
HINGED LID CONTAINERS**

These patented hinged containers provides superior security and enhances the look of product with their crystal clear clarity. Perfect for cold pasta, fruit salad, leafy green salad, nuts, snack mixes, candy, desserts, and more. Ideal for delis, supermarkets, C-stores, and wholesale clubs.

It can be made from post-consumer recycled PET (rPET), provide environmental benefits and meet customer demand for more sustainable food packaging.



**4oz**

RPTTE4AD  
110 x 90 x 32  
780 PCS / CTN.  
CTN. SIZE (mm)  
560 x 465 x 419  
3.85 CU.FT.  
0.11 CBM  
8.7 KG / 19.1 LBS



**6oz**

RPTTE6AD  
110 x 90 x 44  
780 PCS / CTN.  
CTN. SIZE (mm)  
565 x 465 x 431  
4.00 CU.FT.  
0.11 CBM  
11.0 KG / 24.3 LBS



**8oz**

RPTTE8-R  
147 x 128 x 39  
240 PCS / CTN.  
CTN. SIZE (mm)  
527 x 314 x 329  
1.92 CU.FT.  
0.05 CBM  
5.0 KG / 10.9 LBS



**12oz**

RPTTE12-R  
147 x 128 x 51  
240 PCS / CTN.  
CTN. SIZE (mm)  
527 x 314 x 342  
2.00 CU.FT.  
0.06 CBM  
5.2 KG / 11.5 LBS



**16oz**

RPTTE16-R  
147 x 128 x 65  
240 PCS / CTN.  
CTN. SIZE (mm)  
527 x 314 x 356  
2.08 CU.FT.  
0.06 CBM  
6.7 KG / 14.7 LBS

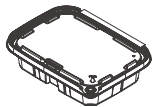

**20oz**

RPTTE20N-R  
189 x 145 x 46  
200 PCS / CTN.  
CTN. SIZE (mm)  
380 x 312 x 516  
2.16 CU.FT.  
0.06 CBM  
7.3 KG / 16.2 LBS



**20oz**

RPTTE20A  
189 x 147 x 51  
200 PCS / CTN.  
CTN. SIZE (mm)  
605 x 395 x 345  
2.91 CU.FT.  
0.08 CBM  
7.4 KG / 16.2 LBS



**24oz**

RPTTE24-R  
189 x 145 x 57  
200 PCS / CTN.  
CTN. SIZE (mm)  
380 x 312 x 528  
2.21 CU.FT.  
0.06 CBM  
8.0 KG / 17.7 LBS



**32oz**

RPTTE32-R  
189 x 146 x 70  
200 PCS / CTN.  
CTN. SIZE (mm)  
380 x 312 x 540  
2.26CU.FT.  
0.06 CBM  
8.6 KG / 19.0 LBS

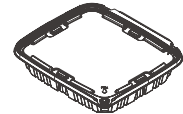

**35oz**

RPTTE35  
223 x 201 x 46  
134 PCS / CTN.  
CTN. SIZE (mm)  
455 x 425 x 455  
3.11 CU.FT.  
0.09 CBM  
8.4 KG / 18.6 LBS

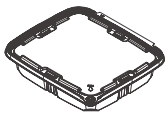

**35oz SMOOTH WALL**

RPTTE35SW-R  
223 x 201 x 46  
150 PCS / CTN.  
CTN. SIZE (mm)  
442 x 375 x 465  
2.72 CU.FT.  
0.08 CBM  
9.3 KG / 20.5 LBS

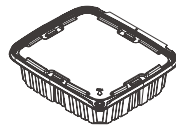

**48oz**

RPTTE48N  
223 x 201 x 60  
134 PCS / CTN.  
CTN. SIZE (mm)  
455 x 425 x 470  
3.21 CU.FT.  
0.09 CBM  
9.0 KG / 19.8 LBS

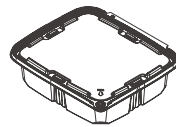

**48oz SMOOTH WALL**

RPTTE48SW-R  
223 x 201 x 60  
150 PCS / CTN.  
CTN. SIZE (mm)  
425 x 400 x 475  
2.85 CU.FT.  
0.08 CBM  
9.9 KG / 21.9 LBS

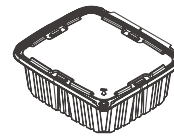

**64oz**

RPTTE64N  
223 x 201 x 77  
134 PCS / CTN.  
CTN. SIZE (mm)  
475 x 425 x 470  
3.35 CU.FT.  
0.09 CBM  
10.5 KG / 23.1 LBS

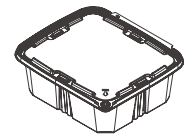

**64oz SMOOTH WALL**

RPTTE64SW-R  
223 x 201 x 77  
150 PCS / CTN.  
CTN. SIZE (mm)  
425 x 425 x 475  
3.03 CU.FT.  
0.09 CBM  
11.6 KG / 25.6 LBS

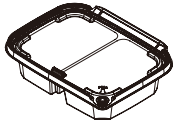

**20oz** 2 comp.

RPTTE20-2C  
189 x 145 x 46  
200 PCS / CTN.  
CTN. SIZE (mm)  
605 x 395 x 325  
2.74 CU.FT.  
0.08 CBM  
8.0 KG / 17.7 LBS

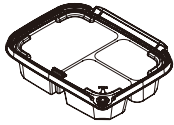

**20oz** 3 comp.

RPTTE20-3C  
189 x 145 x 46  
200 PCS / CTN.  
CTN. SIZE (mm)  
605 x 395 x 325  
2.74 CU.FT.  
0.08 CBM  
8.0 KG / 17.7 LBS

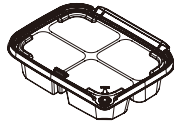

**20oz** 4 comp.

RPTTE20-4C  
189 x 145 x 46  
200 PCS / CTN.  
CTN. SIZE (mm)  
605 x 395 x 325  
2.74 CU.FT.  
0.08 CBM  
8.0 KG / 17.7 LBS



## BUT-N-LOC® TAMPER EVIDENT 2, 3, 4-COMPARTMENT CONTAINERS



## BUT-N-LOC® TAMPER EVIDENT DOME LID 4 CELL CONTAINER

With 4 cell easily separate different foods and ensure that flavors don't mix.

Hinge design ensures the base and lid remain attached and the dome lid provides more capacity.

Great choice for carrying a variety of foods. Ideal for delis, C-stores, supermarkets, and wholesale clubs.

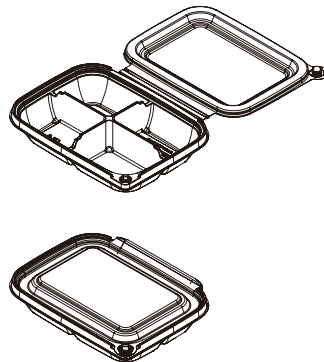

**16oz**

RPTTE16SP4C  
189 x 143 x 38  
460 PCS / CTN.  
CTN. SIZE (mm)  
609 x 392 x 584  
4.92 CU.FT.  
0.14 CBM  
17.5 KG / 38.5 LBS



# BUT-N-LOC® TAMPER EVIDENT 7x6" HINGED LID CONTAINERS



## 16oz

RPTTE76-16  
181 x 163 x 34  
348 PCS / CTN.  
CTN. SIZE (mm)  
557 x 340 x 576  
3.85 CU.FT.  
0.11 CBM  
11.7 KG / 25.8 LBS



## 24oz

RPTTE76-24H  
181 x 163 x 47  
339 PCS / CTN.  
CTN. SIZE (mm)  
557 x 340 x 576  
3.85 CU.FT.  
0.11 CBM  
13.7 KG / 30.2 LBS



## 24oz

RPTTE76-24HTV  
181 x 163 x 55  
339 PCS / CTN.  
CTN. SIZE (mm)  
557 x 340 x 576  
3.85 CU.FT.  
0.11 CBM  
12.7 KG / 27.9 LBS



## 32oz

RPTTE76-32H  
181 x 163 x 66  
315 PCS / CTN.  
CTN. SIZE (mm)  
557 x 340 x 580  
3.88 CU.FT.  
0.11 CBM  
14.4 KG / 31.7 LBS



RPTTE76-48JSV  
**Fluid Catcher  
Design**



## 48oz

RPTTE76-48JSV  
181 x 163 x 90  
196 PCS / CTN.  
CTN. SIZE (mm)  
376 x 340 x 595  
2.69 CU.FT.  
0.08 CBM  
12.7 KG / 27.9 LBS

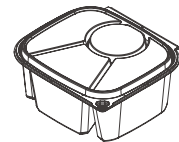

## 35oz 4 comp.

RPTTE76-4CTV  
181 x 163 x 71  
264 PCS / CTN.  
CTN. SIZE (mm)  
557 x 340 x 594  
3.97 CU.FT.  
0.11 CBM  
17.5 KG / 38.6 LBS

VG's patented **But-N-Loc®** tamper evident hinged sandwich wedge is ideal for any sandwich shop, café, deli, or canteen.

The high-clarity material and contoured design ensures superb product visibility and attractive presentation for ready-made sandwich.

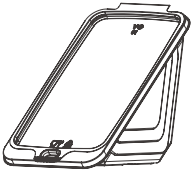

RPTTESW  
 142 x 101 x 129  
 250 PCS / CTN.  
 CTN. SIZE (mm)  
 525 x 395 x 360  
 2.64 CU.FT.  
 0.07 CBM  
 7.2 KG / 15.9 LBS



## BUT-N-LOC® TAMPER EVIDENT HINGED SANDWICH WEDGE



## BUT-N-LOC® TAMPER EVIDENT HINGED WRAP CONTAINER & SMALL CONTAINER

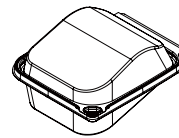

RPTTESWR  
 143 x 130 x 56  
 522 PCS / CTN.  
 CTN. SIZE (mm)  
 630 x 405 x 475  
 4.28 CU.FT.  
 0.12 CBM  
 18.5 KG / 40.7 LBS

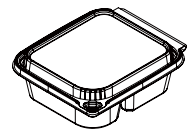

RPTTESWR-2C  
 154 x 130 x 50  
 330 PCS / CTN.  
 CTN. SIZE (mm)  
 405 x 323 x 567  
 2.61 CU.FT.  
 0.07 CBM  
 10.1 KG / 22.3 LBS

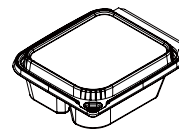

RPTTESWR-3C  
 154 x 130 x 50  
 330 PCS / CTN.  
 CTN. SIZE (mm)  
 405 x 323 x 567  
 2.61 CU.FT.  
 0.07 CBM  
 10.1 KG / 22.3 LBS

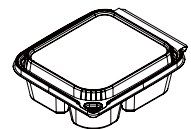

RPTTESWR-4C  
 154 x 130 x 50  
 330 PCS / CTN.  
 CTN. SIZE (mm)  
 405 x 323 x 567  
 2.61 CU.FT.  
 0.07 CBM  
 10.1 KG / 22.3 LBS



# BUT-N-LOC. TAMPER EVIDENT TRAY 9x13" 7 CELL

This 7 compartment container is perfect for leaf or pasta salads, cut vegetables, cut fruit, nuts, candies and other specialty foods.

Tight lid fit eliminates leakage, extends shelf life and product freshness and sturdy design allows stacking and bulk display in store.

Lid design ensure various food products remain separate in sealed compartments.

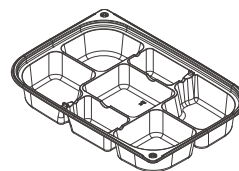

PTTE913-7C  
 350 x 270 x 55  
 100 PCS / CTN.  
 CTN. SIZE (mm)  
 518 x 365 x 455  
 3.04 CU.FT. / 0.09 CBM  
 7.6 KG / 16.7 LBS

VENTED LID

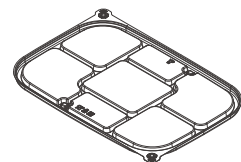

PTTE913-7CLID-V  
 350 x 270 x 10  
 100 PCS / CTN.  
 CTN. SIZE (mm)  
 503 x 365 x 420  
 2.72 CU.FT. / 0.08 CBM  
 7.3 KG / 16.1 LBS



**BUT-N-LOC**

# **TAMPER EVIDENT SQUARE BOWLS**



These patented clear square bowls are perfect for leaf or pasta salads, cut vegetables, cut fruit, nuts, candies and other specialty foods. Ideal for delis, supermarkets, wholesale clubs, and C-stores. Crystal clear lids give the consumer a clear view before buying and they are also crack-resistant and spill-proof to ensure safe and stable handling. Black base available in custom option.

**5.0"** 127mm Dia.

Available in three ranges - 5" (small), 7.5" (Medium), and 9" (Large) in a variety of sizes and single, or 4 compartment options. The stack-ability of these square bowl may improve your shelf space utilization.



**8oz**

PTTESB5-08B  
127 x 127 x 41  
600 PCS / CTN.  
CTN. SIZE (mm)  
525 x 395 x 395  
2.89 CU.FT.  
0.08 CBM  
7.3 KG / 16.1 LBS



**12oz**

PTTESB5-12B  
127 x 127 x 56  
600 PCS / CTN.  
CTN. SIZE (mm)  
525 x 395 x 400  
2.93 CU.FT.  
0.08 CBM  
7.9 KG / 17.4 LBS

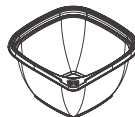

**16oz**

PTTESB5-16B  
127 x 127 x 73  
600 PCS / CTN.  
CTN. SIZE (mm)  
525 x 395 x 410  
3.00 CU.FT.  
0.08 CBM  
9.1 KG / 20.1 LBS



**FLAT LID**

PTTESBFLID5B  
127 x 127 x 8  
600 PCS / CTN.  
CTN. SIZE (mm)  
495 x 375 x 350  
2.29 CU.FT.  
0.06 CBM  
6.9 KG / 15.2 LBS

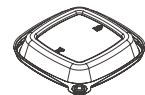

**DOME LID**

PTTESBDLD5B  
127 x 127 x 21  
600 PCS / CTN.  
CTN. SIZE (mm)  
495 x 375 x 340  
2.23 CU.FT.  
0.06 CBM  
6.9 KG / 15.1 LBS

**7.5''**  
191mm Dia.

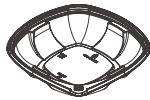

**18oz**  
PTTESB75-18B  
191 x 191 x 40  
300 PCS / CTN.  
CTN. SIZE (mm)  
600 x 405 x 360  
3.09 CU.FT. / .09 CBM  
7.1 KG / 15.5 LBS

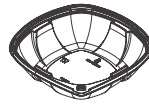

**24oz**  
PTTESB75-24B  
191 x 191 x 49  
300 PCS / CTN.  
CTN. SIZE (mm)  
600 x 405 x 390  
3.35 CU.FT. / 0.09 CBM  
7.7 KG / 17.0 LBS

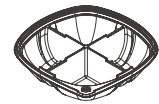

**24oz 4 comp.**  
PTTESB75-24B-4C  
191 x 191 x 49  
300 PCS / CTN.  
CTN. SIZE (mm)  
600 x 405 x 390  
3.35 CU.FT. / 0.09 CBM  
7.7 KG / 17.0 LBS



**32oz**  
PTTESB75-32B  
191 x 191 x 62  
300 PCS / CTN.  
CTN. SIZE (mm)  
600 x 405 x 400  
3.43 CU.FT. / 0.10 CBM  
8.0 KG / 17.7 LBS



**48oz**  
PTTESB75-48B  
191 x 191 x 86  
300 PCS / CTN.  
CTN. SIZE (mm)  
600 x 405 x 435  
3.73 CU.FT. / 0.11 CBM  
9.0 KG / 19.8 LBS

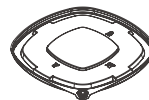

**(18-48oz)**  
PTTESBFLID75B  
181 x 181 x 10  
300 PCS / CTN.  
CTN. SIZE (mm)  
565 x 385 x 355  
2.73 CU.FT. / 0.08 CBM  
6.4 KG / 14.0 LBS

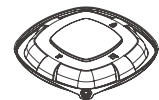

**(18-48oz)**  
PTTESBDLID75B  
181 x 181 x 25  
300 PCS / CTN.  
CTN. SIZE (mm)  
565 x 385 x 350  
2.69 CU.FT. / 0.08 CBM  
6.4 KG / 14.0 LBS

**9.0''**  
229mm Dia.



**40oz**  
PTTESB9-40B  
228 x 228 x 51  
180 PCS / CTN.  
CTN. SIZE (mm)  
480 x 250 x 470  
1.99 CU.FT. / 0.06 CBM  
6.5 KG / 14.3 LBS

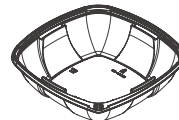

**48oz**  
PTTESB9-48B  
228 x 228 x 61  
180 PCS / CTN.  
CTN. SIZE (mm)  
480 x 250 x 565  
2.39 CU.FT. / 0.07 CBM  
6.6 KG / 14.5 LBS

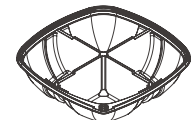

**48oz 4 comp.**  
PTTESB9-48B-4C  
228 x 228 x 61  
180 PCS / CTN.  
CTN. SIZE (mm)  
480 x 250 x 565  
2.39 CU.FT. / 0.07 CBM  
6.6 KG / 14.5 LBS

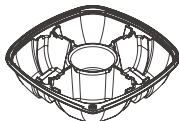

**48oz 5 comp.**  
PTTESB9-48B-5C  
228 x 228 x 61  
180 PCS / CTN.  
CTN. SIZE (mm)  
480 x 250 x 563  
2.38 CU.FT. / 0.07 CBM  
7.1 KG / 15.7 LBS

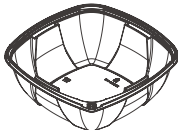

**64oz**  
PTTESB9-64B  
228 x 228 x 79  
180 PCS / CTN.  
CTN. SIZE (mm)  
480 x 250 x 590  
2.50 CU.FT. / 0.07 CBM  
7.7 KG / 17.0 LBS

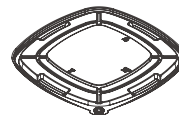

**(40-64oz)**  
PTTESBFLID9B  
218 x 218 x 12  
180 PCS / CTN.  
CTN. SIZE (mm)  
480 x 250 x 475  
2.01 CU.FT. / 0.06 CBM  
6.0 KG / 13.1 LBS

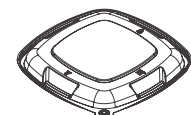

**(40-64oz)**  
PTTESBDLID9B  
218 x 218 x 25  
180 PCS / CTN.  
CTN. SIZE (mm)  
480 x 250 x 455  
1.93 CU.FT. / 0.05 CBM  
5.9 KG / 13.0 LBS



**BUT-N-LOC. TAMPER EVIDENT  
SQUARE DELI CONTAINERS**

These patented clear containers are available in five base sizes: 8, 12, 16, 24 & 32oz with one common lid fit for all sizes. A recessed lid allows for stable stacking to maximize shelf space. Available in bulk and combo (base+lid) packs.

Perfect for cold, ready-to-eat foods, like: pasta salad, cut fruit, nuts and candy. Ideal for delis, C-stores, supermarkets, and wholesale clubs.

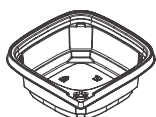

**8oz 260ml**

PTTESDC08  
121 x 121 x 45  
500 PCS / CTN.  
CTN. SIZE (mm)  
625 x 265 x 330  
1.93 CU.FT.  
0.05 CBM  
7.0 KG / 15.5 LBS

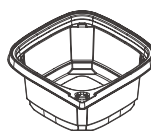

**12oz 360ml**

PTTESDC12  
121 x 121 x 59  
500 PCS / CTN.  
CTN. SIZE (mm)  
625 x 265 x 360  
2.10 CU.FT.  
0.06 CBM  
9.1 KG / 20.1 LBS

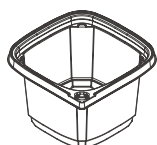

**16oz 530ml**

PTTESDC16  
121 x 121 x 78  
500 PCS / CTN.  
CTN. SIZE (mm)  
625 x 265 x 380  
2.22 CU.FT.  
0.06 CBM  
10.9 KG / 23.9 LBS

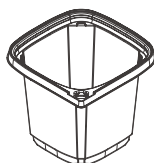

**24oz 710ml**

PTTESDC24  
121 x 121 x 102  
500 PCS / CTN.  
CTN. SIZE (mm)  
625 x 265 x 430  
2.51 CU.FT.  
0.07 CBM  
12.9 KG / 28.4 LBS

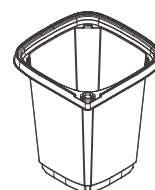

**32oz 910ml**

PTTESDC32  
121 x 121 x 133  
500 PCS / CTN.  
CTN. SIZE (mm)  
625 x 265 x 500  
2.92 CU.FT.  
0.08 CBM  
16.9 KG / 37.4 LBS

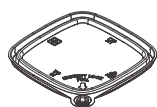

**LID  
(8-32oz)**

PTTESDCLID  
116 x 116 x 7  
500 PCS / CTN.  
CTN. SIZE (mm)  
580 x 250 x 290  
1.48 CU.FT.  
0.04 CBM  
5.0 KG / 11.1 LBS

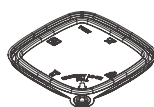

**LID VENTED  
(8-32oz)**

PTTESDCLID-V  
116 x 116 x 7  
500 PCS / CTN.  
CTN. SIZE (mm)  
580 x 250 x 290  
1.48 CU.FT.  
0.04 CBM  
5.0 KG / 11.1 LBS

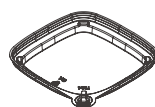

**LID RECESSED  
(8-32oz)**

PTTESDCLID  
116 x 116 x 7  
500 PCS / CTN.  
CTN. SIZE (mm)  
580 x 250 x 295  
1.51 CU.FT.  
0.04 CBM  
5.0 KG / 11.1 LBS



**BUT-N-LOC. TAMPER EVIDENT  
FLAT PANEL PARFAIT CUPS**

These cups are suitable for cut fruit, cut veggies, cookies, biscuits, yogurt parfaits and other snacks.

Fits into the center console cup holders of most cars. Besides, the flat panel design makes it easy to apply a label and have it lay flat.



**9oz 278ml**  
 RPTTEFPC-09  
 111 x 100 x 72  
 500 PCS / CTN.  
 CTN. SIZE (mm)  
 580 x 425 x 385  
 3.35 CU.FT.  
 0.09 CBM  
 11.2 KG / 24.7 LBS



**11oz 335ml**  
 RPTTEFPC-11  
 111 x 100 x 88  
 500 PCS / CTN.  
 CTN. SIZE (mm)  
 580 x 425 x 410  
 3.57 CU.FT.  
 0.10 CBM  
 12.9 KG / 28.4 LBS



**13oz 400ml**  
 RPTTEFPC-13  
 111 x 100 x 108  
 450 PCS / CTN.  
 CTN. SIZE (mm)  
 580 x 425 x 400  
 3.48 CU.FT.  
 0.10 CBM  
 9.8 KG / 21.6 LBS

VENTED



**9oz 278ml**  
 RPTTEFPC-09V  
 111 x 100 x 72  
 500 PCS / CTN.  
 CTN. SIZE (mm)  
 580 x 425 x 385  
 3.35 CU.FT.  
 0.09 CBM  
 11.2 KG / 24.7 LBS

VENTED



**11oz 335ml**  
 RPTTEFPC-11V  
 111 x 100 x 88  
 500 PCS / CTN.  
 CTN. SIZE (mm)  
 580 x 425 x 410  
 3.57 CU.FT.  
 0.10 CBM  
 12.9 KG / 28.4 LBS

VENTED



**13oz 400ml**  
 RPTTEFPC-13V  
 111 x 100 x 108  
 450 PCS / CTN.  
 CTN. SIZE (mm)  
 580 x 425 x 400  
 3.48 CU.FT.  
 0.10 CBM  
 9.8 KG / 21.6 LBS

INSERT



**4oz 120ml**  
 RPTTEFPC-IN  
 94 x 81 x 36  
 1,200 PCS / CTN.  
 CTN. SIZE (mm)  
 501 x 391 x 315  
 2.18 CU.FT.  
 0.06 CBM  
 6.4 KG / 14.0 LBS

INSERT 2C



**4oz 110ml**  
 RPTTEFPC-IN2  
 94 x 81 x 36  
 1,200 PCS / CTN.  
 CTN. SIZE (mm)  
 501 x 391 x 315  
 2.18 CU.FT.  
 0.06 CBM  
 7.6 KG / 16.7 LBS



# TEAR OFF STRIP

TAMPER EVIDENT  
HINGED CONTAINER SERIES



Tear strip locks provide protection to ensure that the container has not been opened since the product was packaged.

Special patented curved design that reduces sharp edges after tearing.



# **TAMPER EVIDENT TEAR OFF STRIP HINGED CONTAINERS**



**8oz**

T08

147 x 128 x 39  
240 PCS / CTN.  
CTN. SIZE (mm)  
527 x 314 x 329  
1.92 CU.FT.  
0.05 CBM  
4.8 KG / 10.7 LBS



**12oz**

T012

147 x 128 x 51  
240 PCS / CTN.  
CTN. SIZE (mm)  
527 x 314 x 342  
2.00 CU.FT.  
0.06 CBM  
5.2 KG / 11.5 LBS



**16oz**

T016

147 x 128 x 65  
240 PCS / CTN.  
CTN. SIZE (mm)  
527 x 314 x 356  
2.08 CU.FT.  
0.06 CBM  
6.2 KG / 13.7 LBS

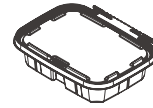

**20oz**

T020

189 x 145 x 46  
200 PCS / CTN.  
CTN. SIZE (mm)  
380 x 312 x 516  
2.16 CU.FT.  
0.06 CBM  
7.4 KG / 16.2 LBS

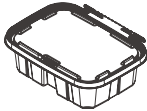

**24oz**

T024

189 x 143 x 57  
200 PCS / CTN.  
CTN. SIZE (mm)  
380 x 312 x 528  
2.21 CU.FT.  
0.06 CBM  
8.0 KG / 17.7 LBS

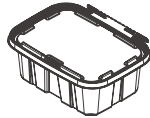

**32oz**

T032

189 x 146 x 70  
200 PCS / CTN.  
CTN. SIZE (mm)  
380 x 312 x 540  
2.26 CU.FT.  
0.06 CBM  
8.4 KG / 18.6 LBS

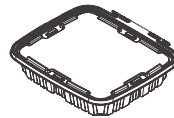

**35oz**

T035

223 x 201 x 44  
180 PCS / CTN.  
CTN. SIZE (mm)  
455 x 425 x 455  
3.11 CU.FT.  
0.09 CBM  
11.0 KG / 24.2 LBS

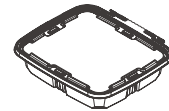

**35oz SMOOTH WALL**

T035SW

223 x 201 x 44  
180 PCS / CTN.  
CTN. SIZE (mm)  
455 x 425 x 455  
3.11 CU.FT.  
0.09 CBM  
11.0 KG / 24.2 LBS

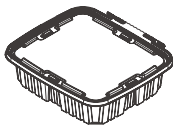

**48oz**

T048

223 x 201 x 60  
176 PCS / CTN.  
CTN. SIZE (mm)  
455 x 425 x 470  
3.21 CU.FT.  
0.09 CBM  
11.5 KG / 25.3 LBS

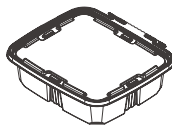

**48oz SMOOTH WALL**

T048SW

223 x 201 x 60  
176 PCS / CTN.  
CTN. SIZE (mm)  
455 x 425 x 470  
3.21 CU.FT.  
0.09 CBM  
11.5 KG / 25.3 LBS

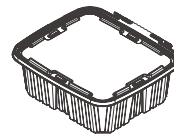

**64oz**

T064

223 x 201 x 77  
164 PCS / CTN.  
CTN. SIZE (mm)  
475 x 425 x 470  
3.35 CU.FT.  
0.09 CBM  
12.6 KG / 27.8 LBS

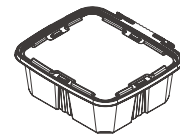

**64oz SMOOTH WALL**

T064SW

223 x 201 x 77  
164 PCS / CTN.  
CTN. SIZE (mm)  
475 x 425 x 470  
3.35 CU.FT.  
0.09 CBM  
12.6 KG / 27.8 LBS



# TAMPER EVIDENT HINGED SQUARE TEAR OFF STRIP CONTAINER



**8oz**

TOSQ408

128 x 120 x 40

540 PCS / CTN.

CTN. SIZE (mm)

527 x 375 x 563

3.93 CU.FT.

0.11 CBM

11.4 KG / 25.2 LBS



**12oz**

TOSQ412

128 x 120 x 54

414 PCS / CTN.

CTN. SIZE (mm)

527 x 375 x 460

3.21 CU.FT.

0.09 CBM

10.6 KG / 23.3 LBS



**16oz**

TOSQ416

128 x 120 x 75

390 PCS / CTN.

CTN. SIZE (mm)

527 x 375 x 470

3.28 CU.FT.

0.09 CBM

13.0 KG / 28.6 LBS



**24oz**

TOSQ424

128 x 120 x 100

330 PCS / CTN.

CTN. SIZE (mm)

527 x 375 x 463

3.23 CU.FT.

0.09 CBM

14.2 KG / 31.4 LBS



**32oz**

TOSQ432

128 x 120 x 129

300 PCS / CTN.

CTN. SIZE (mm)

527 x 375 x 438

3.06 CU.FT.

0.09 CBM

14.7 KG / 32.5 LBS



# TAMPER EVIDENT HINGED ROUND TEAR OFF STRIP CONTAINER



## 8oz

TOR408V  
135 x 131 x 44  
444 PCS / CTN.  
CTN. SIZE (mm)  
558 x 407 x 576  
4.61 CU.FT.  
0.13 CBM  
12.6 KG / 27.8 LBS



## 12oz

TOR412V  
135 x 131 x 60  
420 PCS / CTN.  
CTN. SIZE (mm)  
558 x 407 x 572  
4.58 CU.FT.  
0.13 CBM  
15.4 KG / 33.9 LBS



## 16oz

TOR416V  
135 x 131 x 76  
408 PCS / CTN.  
CTN. SIZE (mm)  
558 x 407 x 576  
4.61 CU.FT.  
0.13 CBM  
16.8 KG / 37.1 LBS



## 24oz

TOR424V  
135 x 131 x 107  
390 PCS / CTN.  
CTN. SIZE (mm)  
558 x 407 x 574  
4.60 CU.FT.  
0.13 CBM  
16.7 KG / 36.8 LBS



## 25oz

TOR425P  
135 x 131 x 122  
402 PCS / CTN.  
CTN. SIZE (mm)  
558 x 407 x 576  
4.61 CU.FT.  
0.13 CBM  
17.8 KG / 39.2 LBS



## 32oz

TOR432V  
135 x 131 x 148  
312PCS / CTN.  
CTN. SIZE (mm)  
558 x 407 x 556  
4.46 CU.FT.  
0.13 CBM  
16.9 KG / 37.2 LBS



# TAMPER EVIDENT HINGED TEAR OFF PARFAIT CUP



**8oz**  
TORPC8  
114 x 109 x 61  
456 PCS / CTN.  
CTN. SIZE (mm)  
477 x 343 x 573  
3.31 CU.FT.  
0.09 CBM  
7.0 KG / 15.5 LBS



**8oz**  
TORPC8D  
114 x 109 x 89  
456 PCS / CTN.  
CTN. SIZE (mm)  
477 x 343 x 573  
3.31 CU.FT.  
0.09 CBM  
7.0 KG / 15.5 LBS



**12oz**  
TORPC12  
114 x 109 x 86  
432 PCS / CTN.  
CTN. SIZE (mm)  
477 x 343 x 573  
3.31 CU.FT.  
0.09 CBM  
8.6 KG / 19.0 LBS



**12oz**  
TORPC12D  
114 x 109 x 115  
432 PCS / CTN.  
CTN. SIZE (mm)  
477 x 343 x 573  
3.31 CU.FT.  
0.09 CBM  
8.6 KG / 19.0 LBS



**16oz**  
TORPC16  
114 x 109 x 113  
408 PCS / CTN.  
CTN. SIZE (mm)  
477 x 343 x 573  
3.31 CU.FT.  
0.09 CBM  
11. KG / 24.2 LBS



**16oz**  
TORPC16D  
114 x 109 x 140  
408 PCS / CTN.  
CTN. SIZE (mm)  
477 x 343 x 573  
3.31 CU.FT.  
0.09 CBM  
11. KG / 24.2 LBS



DESIGNED FOR  
VG TAMPER EVIDENT  
HINGED LID CONTAINERS

# CLOSING MACHINE



IDEAL DESIGN FOR  
FRESH PRODUCE  
PACKAGING



ACCELERATES  
AND SIMPLIFIES  
CLOSING PROCESS



COMPACT, EASY TO USE,  
CLEAN AND MAINTAIN

## VPA200-1

1975 x 998 x 1055 (mm)

77.8 x 39.3 x 41.5 (in)

150kg (330.7 lbs)

CTN. SIZE (mm) 2180 x 1200 x 1390  
CTN. G.W. 250 KG / 551.2 LBS

VG automatic closing machine is designed specifically for our patented **BUT-N-LOC** tamper evident hinged lid containers, operates with sizes 8oz to 64oz, and processes up to 80 containers per minute. Sturdy aluminum and steel construction with electronic control system for flexible ease of use operation.

Our machine increases productivity through reduced labour costs, improved reliability and output. Ideal secure packaging system for a wide variety of fresh food products, VG automatic closing machines are as efficient as they are effective.



## PET HINGED TYPE DELI CONTAINER

These containers can be made from post-consumer recycled PET (rPET) according to customer needs, provide environmental benefits and meet customer demand for more sustainable food packaging. Our products has been assessed and found conforming to the requirements of U.S.F.D.A. and offer enhanced clarity for superior product visibility, one-piece hinged construction and spill-resistant closures.

Available in 15 most popular sizes from 4 to 64 oz., suitable for main and side dishes and bulk foods, they are the perfect choice for all your deli packaging needs - cold pasta, fruit or potato salad, leafy green salads, sandwiches, dried fruit and nuts, bulk candy, desserts and more. Ideal for supermarkets, delis, wholesale clubs, c-stores.



**4oz**

RPTHLD4  
107 x 95 x 34  
400 PCS / CTN.  
CTN. SIZE (mm)  
550 x 410 x 240  
1.91 CU.FT.  
0.05 CBM  
5.4 KG / 11.9 LBS



**6oz**

RPTHLD6  
107 x 95 x 48  
400 PCS / CTN.  
CTN. SIZE (mm)  
565 x 410 x 240  
1.96 CU.FT.  
0.06 CBM  
6.1 KG / 13.4 LBS



**8oz**

RPTHLD8  
142 x 125 x 35  
200 PCS / CTN.  
CTN. SIZE (mm)  
440 x 265 x 315  
1.30 CU.FT.  
0.04 CBM  
3.9 KG / 8.7 LBS

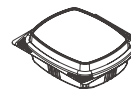

**8oz TALL**

RPTHLD8T  
142 x 125 x 45  
200 PCS / CTN.  
CTN. SIZE (mm)  
480 x 265 x 315  
1.41 CU.FT.  
0.04 CBM  
4.3 KG / 9.6 LBS

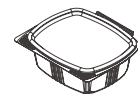

**12oz**

RPTHLD12  
142 x 125 x 49  
200 PCS / CTN.  
CTN. SIZE (mm)  
450 x 265 x 315  
1.33 CU.FT.  
0.04 CBM  
4.1 KG / 9.0 LBS

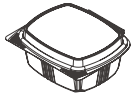

**12oz TALL**

RPTHLD12T  
142 x 125 x 59  
200 PCS / CTN.  
CTN. SIZE (mm)  
490 x 265 x 315  
1.44 CU.FT.  
0.04 CBM  
4.3 KG / 9.6 LBS

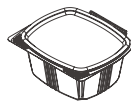

**16oz**

RPTHLD16  
142 x 125 x 63  
200 PCS / CTN.  
CTN. SIZE (mm)  
510 x 265 x 315  
1.50 CU.FT.  
0.04 CBM  
4.7 KG / 10.3 LBS

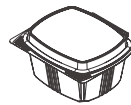

**16oz TALL**

RPTHLD16T  
142 x 125 x 72  
200 PCS / CTN.  
CTN. SIZE (mm)  
510 x 265 x 315  
1.50 CU.FT.  
0.04 CBM  
5.0 KG / 11.1 LBS

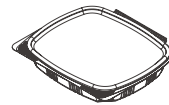

**16oz SHALLOW**

RPTHLD16S  
183 x 161 x 33  
200 PCS / CTN.  
CTN. SIZE (mm)  
425 x 350 x 390  
2.05 CU.FT.  
0.06 CBM  
7.2 KG / 15.9 LBS

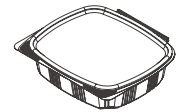

**24oz**

RPTHLD24  
183 x 161 x 47  
200 PCS / CTN.  
CTN. SIZE (mm)  
480 x 350 x 390  
2.31 CU.FT.  
0.07 CBM  
7.9 KG / 17.3 LBS

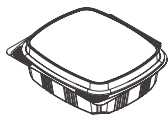

**24oz TALL**

RPTHLD24T  
183 x 161 x 57  
200 PCS / CTN.  
CTN. SIZE (mm)  
520 x 350 x 390  
2.51 CU.FT.  
0.07 CBM  
8.6 KG / 18.9 LBS

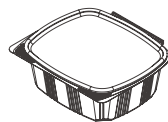

**32oz**

RPTHLD32  
183 x 161 x 65  
200 PCS / CTN.  
CTN. SIZE (mm)  
510 x 350 x 390  
2.46 CU.FT.  
0.07 CBM  
8.6 KG / 18.9 LBS

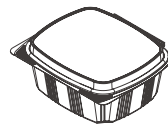

**32oz TALL**

RPTHLD32T  
183 x 161 x 75  
200 PCS / CTN.  
CTN. SIZE (mm)  
510 x 350 x 390  
2.46 CU.FT.  
0.07 CBM  
8.4 KG / 18.4 LBS

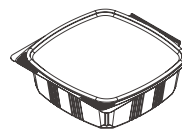

**48oz**

RPTHLD48  
203 x 202 x 63  
200 PCS / CTN.  
CTN. SIZE (mm)  
490 x 430 x 430  
3.20 CU.FT.  
0.09 CBM  
11.4 KG / 25.1 LBS

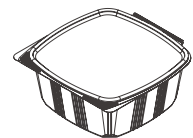

**64oz**

RPTHLD64  
203 x 202 x 84  
200 PCS / CTN.  
CTN. SIZE (mm)  
560 x 430 x 430  
3.66 CU.FT.  
0.10 CBM  
13.0 KG / 28.6 LBS



# PET HINGED TYPE BAKERY CONTAINERS

It's resealable and reliable for delis, concession stands, food trucks, cafes, and any food service establishment that offers take-out.

Crystal clear design provides optimal product visibility, making your food instantly identifiable. Display a variety of popular snack foods such as muffins, cupcakes, or cookies, the possibilities are endless!

label window provides an ideal location for a label or tamper evident seal.

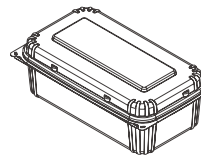

**BHC35**  
 228 x 133 x 82  
 100 PCS / CTN.  
 CTN. SIZE (mm)  
 471 x 288 x 376  
 1.80 CU.FT.  
 0.05 CBM  
 4.5 KG / 9.9 LBS

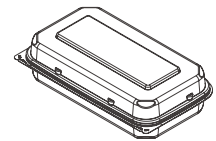

**BHC35-225**  
 228 x 133 x 63  
 280 PCS / CTN.  
 CTN. SIZE (mm)  
 580 x 480 x 462  
 4.54 CUFT  
 0.13 CBM  
 10.6 KG / 23.9 LBS

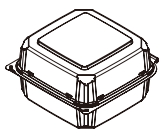

**PTH66**  
 144 x 141 x 79  
 356 PCS / CTN.  
 CTN. SIZE (mm)  
 582 x 341 x 312  
 2.19 CU.FT.  
 0.06 CBM  
 7.9 KG / 17.4 LBS

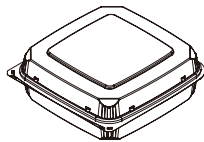

**PTH88**  
 207 x 204 x 70  
 300 PCS / CTN.  
 CTN. SIZE (mm)  
 603 x 430 x 428  
 3.92 CU.FT.  
 0.11 CBM  
 14.2 KG / 31.2 LBS

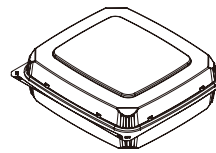

**PTH98**  
 231 x 211 x 70  
 164 PCS / CTN.  
 CTN. SIZE (mm)  
 477 x 340 x 448  
 2.57 CU.FT.  
 0.07 CBM  
 9.8 KG / 21.7 LBS

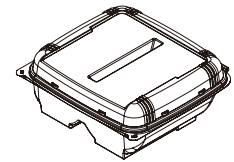

**PTHSJC**  
 231 x 213 x 89  
 100 PCS / CTN.  
 CTN. SIZE (mm)  
 580 x 438 x 256  
 2.30 CU.FT.  
 0.07 CBM  
 6.3 KG / 13.9 LBS

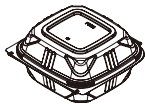

PV756  
 159 x 154 x 79  
 330 PCS / CTN.  
 CTN. SIZE (mm)  
 540 x 340 x 510  
 3.31 CU.FT.  
 0.09 CBM  
 8.4 KG / 18.6 LBS

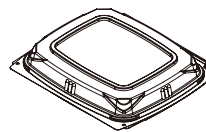

PV727  
 228 x 199 x 51  
 110 PCS / CTN.  
 CTN. SIZE (mm)  
 559 x 415 x 252  
 2.06 CU.FT.  
 0.06 CBM  
 5.3 KG / 11.7 LBS

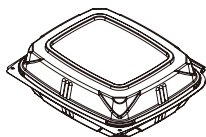

PV747  
 228 x 198 x 72  
 110 PCS / CTN.  
 CTN. SIZE (mm)  
 570 x 415 x 252  
 2.10 CU.FT.  
 0.06 CBM  
 6.1 KG / 13.4 LBS

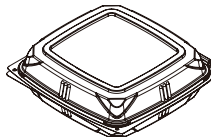

PV785  
 237 x 233 x 74  
 100 PCS / CTN.  
 CTN. SIZE (mm)  
 480 x 450 x 270  
 2.06 CU.FT.  
 0.06 CBM  
 6.9 KG / 15.3 LBS

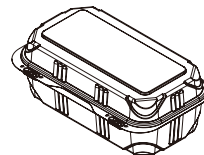

PV735  
 229 x 114 x 84  
 250 PCS / CTN.  
 CTN. SIZE (mm)  
 581 x 310 x 485  
 3.08 CU.FT.  
 0.09 CBM  
 11.7 KG / 25.9 LBS



# HINGED TYPE BUTTER LETTUCE CONTAINERS

This container offers both superb clarity and protection on the go, and helps maintain lettuce freshness.

Well suited for food processors & packers, wholesale clubs, and supermarkets.

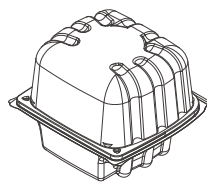

PTHBLC-1  
 185 x 167 x 144  
 270 PCS / CTN.  
 CTN. SIZE (mm)  
 605 x 399 x 353  
 3.01 CU.FT.  
 0.09 CBM  
 11.8 KG / 26.1 LBS

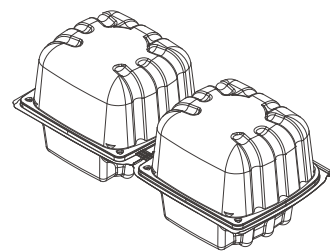

PTHBLC-2  
 380 x 164 x 144  
 135 PCS / CTN.  
 CTN. SIZE (mm)  
 605 x 399 x 353  
 3.01 CU.FT.  
 0.09 CBM  
 11.8 KG / 26.1 LBS



# SINGLE / DOUBLE CLAMSHELL



This container is ideal for herb with root ball attached.

The clarity and air proof function offer the contents visibility and freshness maintenance.

It's perfect for supermarket display and space-saving storage.

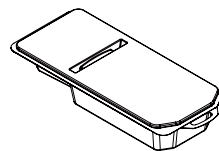

## SINGLE CLAMSHELL

PTHSLHCL-NSL  
 231 x 75 x 37  
 318 PCS / CTN.  
 CTN. SIZE (mm)  
 631 x 505 x 256  
 2.88 CU.FT.  
 0.08 CBM  
 9.43 KG / 20.8 LBS

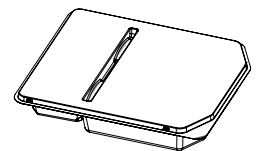

## DOUBLE CLAMSHELL

PTHDLHCL-NSL  
 199 x 186 x 38  
 200 PCS / CTN.  
 CTN. SIZE (mm)  
 454 x 387 x 455  
 2.82 CU.FT.  
 0.08 CBM  
 10.70 KG / 23.6 LBS



# PET CLEAR 4 COMP. SNACK CONTAINER

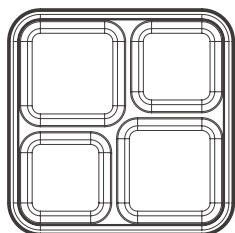

6" x 6" in

This 6"x6"4 compartment square snack container is ideal for separating equal quantities of food, ideal for patron's picnics, lunches, or on-the-go snacks. This container let you create variety of meal and snack combos and showcase them.

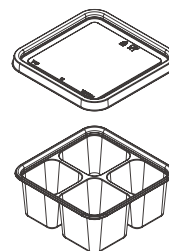

PTSNAK4  
153 x 153 x 63  
300 SETS / CTN.  
CTN. SIZE (mm)  
700 x 490 x 340  
4.12 CU.FT.  
0.12 CBM  
13.2 KG / 29.0 LBS



# PET CLEAR ROUND DELI CONTAINERS

VG PET clear round deli containers are perfect for high quality in store presentation and packaging a wide variety of fresh and precooked food, salads, fruit, sauces, nuts, confectionery and more. Leak resistant for safe & convenient transportation.

The crystal clear appearance allows you to set up eye-catching food displays that look more flavorful and delicious, and stimulate impulse purchases.

One common size snap-fit lid helps maintain freshness. Product is stackable for maximum shelf space utilization. Well suited for supermarkets, food processors & packers, wholesale clubs, and C-stores.



**4.61"**  
117mm Dia.

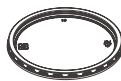

**RECESSED LID**  
PTRDCLIDIN  
122 x 8  
500 PCS / CTN.  
CTN. SIZE (mm)  
630 x 250 x 240  
1.33 CU.FT.  
0.04 CBM  
3.2 KG / 7.1 LBS



**OVERCAP LID**  
PTRDCLIDOUT  
120 x 13  
500 PCS / CTN.  
CTN. SIZE (mm)  
630 x 250 x 240  
1.33 CU.FT.  
0.04 CBM  
3.1 KG / 6.9 LBS



**DOMELID**  
PTRDCDOME  
120 x 45  
500 PCS / CTN.  
CTN. SIZE (mm)  
630 x 250 x 225  
1.25 CU.FT.  
0.04 CBM  
4.3 KG / 9.4 LBS



**8oz**  
PTRDC08  
117 x 97 x 41  
500 PCS / CTN.  
CTN. SIZE (mm)  
600 x 250 x 340  
1.80 CU.FT.  
0.05 CBM  
5.2 KG / 11.4 LBS



**12oz**  
PTRDC12  
117 x 94 x 60  
500 PCS / CTN.  
CTN. SIZE (mm)  
600 x 250 x 345  
1.83 CU.FT.  
0.05 CBM  
6.2 KG / 13.7 LBS



**16oz**  
PTRDC16  
117 x 91 x 75  
500 PCS / CTN.  
CTN. SIZE (mm)  
600 x 250 x 365  
1.93 CU.FT.  
0.05 CBM  
8.7 KG / 19.3 LBS



**24oz**  
PTRDC24  
117 x 86 x 110  
500 PCS / CTN.  
CTN. SIZE (mm)  
600 x 250 x 410  
2.17 CU.FT.  
0.06 CBM  
10.3 KG / 22.6 LBS



**32oz**  
PTRDC32  
117 x 82 x 142  
500 PCS / CTN.  
CTN. SIZE (mm)  
600 x 250 x 490  
2.59 CU.FT.  
0.07 CBM  
11.4 KG / 25.1 LBS



# PET CLEAR 32oz ROUND PRODUCE CONTAINER



## 32oz (172mm)

PTRRC32-D172  
 172 x 120 x 75  
 500 PCS / CTN.  
 CTN. SIZE (mm)  
 375 x 375 x 630  
 3.13 CU.FT.  
 0.09 CBM  
 17.0 KG / 37.5 LBS



## OVERCAP LID

PTRRCLID-D172  
 176 x 8  
 500 PCS / CTN.  
 CTN. SIZE (mm)  
 375 x 375 x 590  
 2.93 CU.FT.  
 0.08 CBM  
 6.0 KG / 13.2 LBS

It's just the right size for single serving salads, fruits, cut veggies, pastas and side items. It's designed for transporting and storing cold food items. Tight lid fit prevents spills – in the store and on the go – and helps maintain product freshness.

You'll have no trouble selling produce, jujube, berries, and even herbs! Ideas for supermarkets, delis, wholesale clubs, and C-stores.



## PET CLEAR SALAD BOWLS

These fresh view bowls are specifically designed to showcase your bakery, deli, produce and “grab-and-go” items. Made of durable, crack-resistant and clear PET, these bowls are the perfect complement for pre-packed or fresh salads and cut fruit. The no-spill lid is also perfect for stacking. Available in bulk or combo pack, and with clear or black bases.



## 175mm Dia.



**18oz**

PTSB18-D175  
175 x 50 x 20

150 SETS / CTN.  
CTN. SIZE (mm)  
543 x 188 x 565  
2.04 CU.FT. / 0.06 CBM  
4.1 KG / 9.1 LBS

300 SETS / CTN.  
CTN. SIZE (mm)  
575 x 533 x 376  
4.07 CU.FT. / 0.12 CBM  
8.2 KG / 18.0 LBS

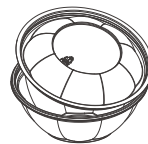

**24oz**

PTSB24-D175  
175 x 62 x 20

150 SETS / CTN.  
CTN. SIZE (mm)  
543 x 188 x 583  
2.10 CU.FT. / 0.06 CBM  
4.7 KG / 10.3 LBS

300 SETS / CTN.  
CTN. SIZE (mm)  
603 x 533 x 376  
4.27 CU.FT. / 0.12 CBM  
9.5 KG / 20.9 LBS

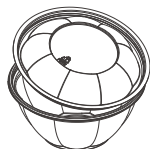

**32oz**

PTSB32-D175  
175 x 83 x 20

150 SETS / CTN.  
CTN. SIZE (mm)  
543 x 188 x 600  
2.16 CU.FT. / 0.06 CBM  
5.4 KG / 12.0 LBS

300 SETS / CTN.  
CTN. SIZE (mm)  
630 x 533 x 376  
4.46 CU.FT. / 0.13 CBM  
11.1 KG / 24.4 LBS

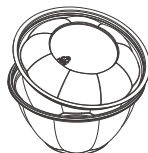

**48oz**

PTSB48-D175  
175 x 112 x 20

150 SETS / CTN.  
CTN. SIZE (mm)  
543 x 188 x 620  
2.23 CU.FT. / 0.06 CBM  
6.9 KG / 15.2 LBS

300 SETS / CTN.  
CTN. SIZE (mm)  
650 x 533 x 376  
4.60 CU.FT. / 0.13 CBM  
13.6 KG / 30.0 LBS

## 225mm Dia.

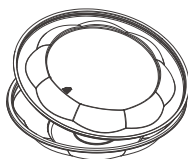

**40oz**

PTSB40-D255  
225 x 50 x 25

100 SETS / CTN.  
CTN. SIZE (mm)  
520 x 276 x 390  
1.98 CU.FT. / 0.06 CBM  
6.1 KG / 13.3 LBS

200 SETS / CTN.  
CTN. SIZE (mm)  
521 x 500 x 542  
4.98 CU.FT. / 0.14 CBM  
12.4 KG / 27.3 LBS

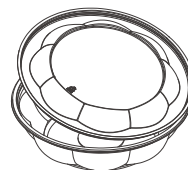

**64oz**

TSB64-D255  
225 x 73 x 25

100 SETS / CTN.  
CTN. SIZE (mm)  
520 x 276 x 445  
2.25 CU.FT. / 0.06 CBM  
6.8 KG / 15.1 LBS

200 SETS / CTN.  
CTN. SIZE (mm)  
535 x 510 x 542  
5.22 CU.FT. / 0.15 CBM  
13.9 KG / 30.6 LBS



## PET CAKE & PIE CONTAINERS



VG Cake & Bakery Container with clear dome lids are great for selling and merchandising your 6-10" cakes or pies!

The base is made of durable black PET, and an included clear dome lid allows for optimum viewing of every decorated side as well as protecting your sweets during transport.

Easy to label lid side



## FEATURES AND BENEFITS

- Ideal for supermarkets, bakeries and wholesale clubs.
- Suitable for cakes, pies, and desserts.
- Full view of the product at all times.
- PET lid offers both superb clarity and protection against damage.
- Packaging boasts a solid dome lid to base lock.

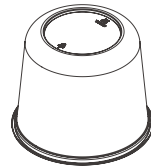

### 6"

PTCC6

196 x 205 x 168.5

100 SETS / CTN.

CTN. SIZE (mm)

800 x 410 x 225

2.61 CU.FT. / 0.07 CBM

8.5 KG / 18.8 LBS

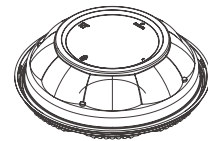

### 9" PIE

PTPC9SL

153 x 258 x 100

110 SETS / CTN.

CTN. SIZE (mm)

640 x 530 x 270

3.23 CU.FT. / 0.09 CBM

9.2 KG / 20.3 LBS

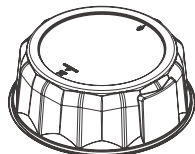

### 8" SINGLE

NFPTCC8SL

259 x 265 x 102.8

100 SETS / CTN.

CTN. SIZE (mm)

620 x 530 x 285

3.31 CU.FT. / 0.09 CBM

10.5 KG / 23.2 LBS

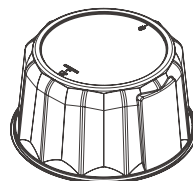

### 8" DOUBLE

NFPTCC8DL

259 x 265 x 149

100 SETS / CTN.

CTN. SIZE (mm)

620 x 530 x 285

3.31 CU.FT. / 0.09 CBM

10.9 KG / 24.1 LBS

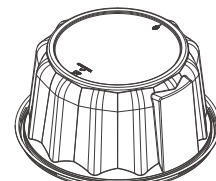

### 10"

PTCC10DL

259 x 284 x 151

50 SETS / CTN.

CTN. SIZE (mm)

560 x 445 x 305

2.68 CU.FT. / 0.08 CBM

6.9 KG / 15.2 LBS



## **PET CLEAR CUPS & LIDS** **4 DIAMETER RIM SIZES**

The glass-like clarity of clear cups allows the appeal of your food and drink to shine through. Whether for iced beverages, smoothies, frozen drinks, on-the-go snacks or parfaits, they give your product that high-end look and feel. Made of crack-resistant PET, these cups have outstanding strength and durability.

They are not susceptible to flavor or odor transfer and have smooth rolled rims for safe and comfortable drinking. You can also create new food combinations with our cup inserts.

## FEATURES & BENEFITS

- Four rim diameter sizes: 78, 92, 98, and 107mm. 4oz cup inserts to fits 92mm & 98mm rim cups.
- Large and flat area for customer branding. Printing up to 6-colors.
- Excellent for coffee shops, restaurants, supermarkets, C-stores and sports venues.





Available in PET, Blended PET, or RPET



**9oz**

PTC09SW-D92  
92 x 55 x 72  
1,000 PCS / CTN.  
CTN. SIZE (mm)  
476 x 386 x 348  
2.26 CU.FT.  
0.06 CBM  
10.1 KG / 22.2 LBS



**12oz TALL**

PTC12-D92  
92 x 60 x 106  
1,000 PCS / CTN.  
CTN. SIZE (mm)  
476 x 386 x 435  
2.82 CU.FT.  
0.08 CBM  
12.5 KG / 27.6 LBS



**16oz**

PTC16-D92  
92 x 61 x 124  
1,000 PCS / CTN.  
CTN. SIZE (mm)  
476 x 386 x 545  
3.53 CU.FT.  
0.10 CBM  
14.2 KG / 31.4 LBS



**20oz**

PTC20-D92  
92 x 65 x 148  
1,000 PCS / CTN.  
CTN. SIZE (mm)  
476 x 386 x 430  
2.79 CU.FT.  
0.08 CBM  
17.7 KG / 39.0 LBS



**9oz**

PTC09-D92  
92 x 55 x 73  
1,000 PCS / CTN.  
CTN. SIZE (mm)  
476 x 386 x 348  
2.26 CU.FT.  
0.06 CBM  
10.1 KG / 22.2 LBS



**425ml**

PTC425-D92  
92 x 56 x 118  
1,000 PCS / CTN.  
CTN. SIZE (mm)  
476 x 386 x 425  
2.76 CU.FT.  
0.08 CBM  
12.5 KG / 27.5 LBS



**4oz INSERT**

PTINS-D92  
92 x 67 x 26  
1,000 PCS / CTN.  
CTN. SIZE (mm)  
490 x 214 x 255  
0.94 CU.FT.  
0.03 CBM  
3.5 KG / 7.7 LBS



**NO SLOT**

PTLID-F92NS  
92 x 9  
1,000 PCS / CTN.  
CTN. SIZE (mm)  
485 x 395 x 210  
1.42 CU.FT.  
0.04 CBM  
3.1 KG / 6.8 LBS



**STRAW SLOT**

PTLID-F92SS  
92 x 9  
1,000 PCS / CTN.  
CTN. SIZE (mm)  
485 x 395 x 210  
1.42 CU.FT.  
0.04 CBM  
3.1 KG / 6.8 LBS



**NO HOLE with TAB**

PTLID-F92NS-T  
92 x 11  
1,000 PCS / CTN.  
CTN. SIZE (mm)  
500 x 407 x 262  
1.88 CU.FT.  
0.05 CBM  
3.8 KG / 8.3 LBS



**STRAW SLOT**

PTLID-D92SS  
92 x 45  
1,000 PCS / CTN.  
CTN. SIZE (mm)  
495 x 425 x 210  
1.56 CU.FT.  
0.04 CBM  
4.3 KG / 9.5 LBS



**ROUND HOLE**

PTLID-D92RH  
92 x 45  
1,000 PCS / CTN.  
CTN. SIZE (mm)  
495 x 425 x 210  
1.56 CU.FT.  
0.04 CBM  
4.3 KG / 9.5 LBS



**WIDE HOLE**

PTLID-D92WH  
92 x 38  
1,000 PCS / CTN.  
CTN. SIZE (mm)  
495 x 460 x 210  
1.69 CU.FT.  
0.05 CBM  
4.5 KG / 9.9 LBS



**NO HOLE**

PTLID-D92NH  
92 x 45  
1,000 PCS / CTN.  
CTN. SIZE (mm)  
495 x 425 x 210  
1.56 CU.FT.  
0.04 CBM  
4.3 KG / 9.5 LBS



Available in PET, Blended PET, or RPET



**12/14oz**  
 PTC14-D98  
 98 x 55 x 103  
 1,000 PCS / CTN.  
 CTN. SIZE (mm)  
 506 x 403 x 375  
 2.70 CU.FT.  
 0.08 CBM  
 13.4 KG / 29.5 LBS



**16/18oz**  
 PTC16-D98  
 98 x 63 x 118  
 1,000 PCS / CTN.  
 CTN. SIZE (mm)  
 506 x 403 x 380  
 2.74 CU.FT.  
 0.08 CBM  
 15.7 KG / 34.6 LBS



**20oz**  
 PTC20-D98  
 98 x 59 x 137  
 1,000 PCS / CTN.  
 CTN. SIZE (mm)  
 506 x 403 x 420  
 3.02 CU.FT.  
 0.09 CBM  
 17.4 KG / 38.4 LBS



**24oz**  
 PTC24-D98  
 98 x 62 x 151  
 600 PCS / CTN.  
 CTN. SIZE (mm)  
 400 x 300 x 480  
 2.03 CU.FT.  
 0.06 CBM  
 11.2 KG / 24.7 LBS



**5oz INSERT**  
 PTINS-D98  
 98 x 74 x 30  
 1,000 PCS / CTN.  
 CTN. SIZE (mm)  
 510 x 215 x 325  
 1.26 CU.FT.  
 0.04 CBM  
 4.3 KG / 9.4 LBS



**NO SLOT**  
 PTLID-F98NS  
 98 x 10  
 1,000 PCS / CTN.  
 CTN. SIZE (mm)  
 532 x 432 x 212  
 1.72 CU.FT.  
 0.05 CBM  
 4.0 KG / 8.9 LBS



**STRAW SLOT**  
 PTLID-F98SS  
 98 x 10  
 1,000 PCS / CTN.  
 CTN. SIZE (mm)  
 532 x 432 x 212  
 1.72 CU.FT.  
 0.05 CBM  
 4.0 KG / 8.9 LBS



**STRAWLESS SIP LID**  
 PTLID-S98  
 98 x 23  
 1,000 PCS / CTN.  
 CTN. SIZE (mm)  
 530 x 426 x 235  
 1.87 CU.FT.  
 0.05 CBM  
 4.4 KG / 9.6 LBS



**STRAW SLOT**  
 PTLID-D98SS  
 98 x 46  
 1,000 PCS / CTN.  
 CTN. SIZE (mm)  
 525 x 445 x 225  
 1.86 CU.FT.  
 0.05 CBM  
 5.3 KG / 11.7 LBS

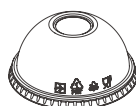

**ROUND HOLE**  
 PTLID-D98RH  
 98 x 46  
 1,000 PCS / CTN.  
 CTN. SIZE (mm)  
 525 x 445 x 225  
 1.86 CU.FT.  
 0.05 CBM  
 5.3 KG / 11.7 LBS



**NO HOLE**  
 PTLID-D98NH  
 98 x 46  
 1,000 PCS / CTN.  
 CTN. SIZE (mm)  
 525 x 445 x 225  
 1.86 CU.FT.  
 0.05 CBM  
 5.3 KG / 11.7 LBS



**WIDE HOLE**  
 PTLID-D98WH  
 98 x 40  
 1,000 PCS / CTN.  
 CTN. SIZE (mm)  
 525 x 445 x 225  
 1.86 CU.FT.  
 0.05 CBM  
 5.3 KG / 11.7 LBS



Available in PET, Blended PET, or RPET



**7oz**  
 PTC07-D78  
 78 x 48 x 81  
 1,000 PCS / CTN.  
 CTN. SIZE (mm)  
 400 x 320 x 330  
 1.49 CU.FT.  
 0.04 CBM  
 8.0 KG / 17.5 LBS



**8oz**  
 PTC08-D78  
 78 x 53 x 81  
 1,000 PCS / CTN.  
 CTN. SIZE (mm)  
 400 x 320 x 420  
 1.90 CU.FT.  
 0.05 CBM  
 7.3 KG / 16.2 LBS



**10oz**  
 PTC10-D78  
 78 x 51 x 103  
 1,000 PCS / CTN.  
 CTN. SIZE (mm)  
 400 x 320 x 440  
 1.99 CU.FT.  
 0.06 CBM  
 8.1 KG / 17.8 LBS



**STRAW SLOT**  
 PTLID-F78SS  
 78 x 7  
 2,000 PCS / CTN.  
 CTN. SIZE (mm)  
 415 x 345 x 340  
 1.72 CU.FT.  
 0.05 CBM  
 4.0 KG / 8.8 LBS



**STRAW SLOT**  
 PTLID-D78RH  
 78 x 37  
 2,000 PCS / CTN.  
 CTN. SIZE (mm)  
 440 x 410 x 330  
 2.10 CU.FT.  
 0.06 CBM  
 5.4 KG / 11.9 LBS



**STRAW SLOT**  
 PTLID-F107SS  
 107 x 11  
 500 PCS / CTN.  
 CTN. SIZE (mm)  
 560 x 240 x 240  
 1.14 CU.FT.  
 0.03 CBM  
 2.2 KG / 4.8 LBS



**STRAW SLOT**  
 PTLID-D107SS  
 107 x 43  
 500 PCS / CTN.  
 CTN. SIZE (mm)  
 590 x 240 x 300  
 1.50 CU.FT.  
 0.04 CBM  
 3.1 KG / 6.9 LBS



**ROUND HOLE**  
 PTLID-D107RH  
 107 x 43  
 500 PCS / CTN.  
 CTN. SIZE (mm)  
 590 x 240 x 300  
 1.50 CU.FT.  
 0.04 CBM  
 3.1 KG / 6.9 LBS



**32oz**  
 PTC32-D107  
 107 x 73 x 175  
 500 PCS / CTN.  
 CTN. SIZE (mm)  
 565 x 455 x 430  
 3.90 CU.FT.  
 0.11 CBM  
 14.9 KG / 32.8 LBS



# PLA BIOPLASTIC CLEAR CUPS & SALAD BOWL



# PLA COMPOSTABLE BIOPLASTICS MADE FROM PLANT STARCHES

## WHAT IS PLA?



PLA (PolyLactic Acid) is made from plants not oil, derived from natural sources like corn starch, cassava, or sugar cane.

## HOW PLA IS MADE?

- 01 Harvesting the corn, extract the starch in the form of glucose.
- 02 Fermentation process turning glucose into lactic acid.
- 03 Turning lactic acid into a polymer, which can be made into PLA resin.



NatureWorks is the world's largest producer of PLA, our PLA clear cups made from 100% NatureWorks Ingeo™ resin produced in the USA.

## 100% BIODEGRADABLE



PLA products will completely biodegrade within 120 days in a commercial compost facility. Return nutrients back into soil.

## LOW CARBON FOOTPRINT



The production of Ingeo® bioplastic emits 75% less greenhouse gas emissions compared to PET.



STORE IN THE COOL PLACE.  
IDEAL BEVERAGE TEMPERATURE WITHIN 40°C / 104°F



**9oz SQUAT**  
PLAC09SW-D92  
92 x 61 x 72  
1,000 PCS / CTN.  
CTN. SIZE (mm)  
476 x 386 x 350  
2.27 CU.FT.  
0.06 CBM  
10.1 KG / 22.2 LBS



**12oz Tall**  
PLAC12-D92  
92 x 59 x 106  
1,000 PCS / CTN.  
CTN. SIZE (mm)  
476 x 386 x 375  
2.43 CU.FT.  
0.07 CBM  
11.3 KG / 25.0 LBS



**16oz**  
PLAC16-D92  
92 x 61 x 125  
1,000 PCS / CTN.  
CTN. SIZE (mm)  
480 x 390 x 375  
2.48 CU.FT.  
0.07 CBM  
13.7 KG / 30.3 LBS

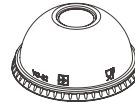

**ROUND HOLE**  
PLALID-D92RH  
92 x 45  
1,000 PCS / CTN.  
CTN. SIZE (mm)  
495 x 460 x 210  
1.69 CU.FT.  
0.05 CBM  
4.1 KG / 9.1 LBS



**STRAW SLOT**  
PLALID-F92SS  
92 x 9  
1,000 PCS / CTN.  
CTN. SIZE (mm)  
485 x 395 x 220  
1.49 CU.FT.  
0.04 CBM  
3.1 KG / 6.8 LBS



**9oz SQUAT**  
PLAC09SW-D96  
96 x 55 x 79  
1,000 PCS / CTN.  
CTN. SIZE (mm)  
504 x 404 x 350  
2.52 CU.FT.  
0.07 CBM  
8.8 KG / 19.5 LBS



**12/14oz**  
PLAC12-D96  
96 x 54 x 106  
1,000 PCS / CTN.  
CTN. SIZE (mm)  
504 x 404 x 385  
2.77 CU.FT.  
0.08 CBM  
11.7 KG / 25.8 LBS



**16/18oz**  
PLAC16-D96  
96 x 61 x 124  
1,000 PCS / CTN.  
CTN. SIZE (mm)  
504 x 404 x 550  
3.95 CU.FT.  
0.11 CBM  
14.0 KG / 30.8 LBS



**20oz**  
PLAC20-D96  
96 x 61 x 141  
1,000 PCS / CTN.  
CTN. SIZE (mm)  
504 x 404 x 610  
4.38 CU.FT.  
0.12 CBM  
15.1 KG / 33.2 LBS



**24oz**  
PLAC24-D96  
96 x 64 x 152  
1,000 PCS / CTN.  
CTN. SIZE (mm)  
504 x 404 x 650  
4.67 CU.FT.  
0.13 CBM  
15.6 KG / 34.4 LBS

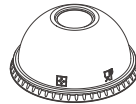

**ROUND HOLE**  
PLALID-D96RH  
96 x 45  
1,000 PCS / CTN.  
CTN. SIZE (mm)  
516 x 416 x 265  
2.01 CU.FT.  
0.06 CBM  
4.7 KG / 10.3 LBS



**STRAW SLOT**  
PLALID-F96SS  
96 x 9  
1,000 PCS / CTN.  
CTN. SIZE (mm)  
514 x 432 x 214  
1.68 CU.FT.  
0.05 CBM  
3.7 KG / 8.3 LBS



STORE IN THE COOL PLACE.  
IDEAL BEVERAGE TEMPERATURE WITHIN 40°C / 104°F



**12/14oz**  
PLAC14-D98  
98 x 56 x 103  
1,000 PCS / CTN.  
CTN. SIZE (mm)  
506 x 403 x 375  
2.70 CU.FT.  
0.08 CBM  
13.0 KG / 28.6 LBS



**16/18oz**  
PLAC16-D98  
98 x 63 x 118  
1,000 PCS / CTN.  
CTN. SIZE (mm)  
508 x 405 x 370  
2.69 CU.FT.  
0.08 CBM  
13.9 KG / 30.6 LBS



**20oz**  
PLAC20-D98  
98 x 60 x 137  
1,000 PCS / CTN.  
CTN. SIZE (mm)  
506 x 403 x 420  
3.02 CU.FT.  
0.09 CBM  
16.1 KG / 35.6 LBS



**24oz**  
PLAC24-D98  
98 x 62 x 150  
600 PCS / CTN.  
CTN. SIZE (mm)  
400 x 300 x 480  
2.03 CU.FT.  
0.06 CBM  
10.1 KG / 22.3 LBS

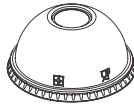

**ROUND HOLE**  
PLALID-D98RH  
98 x 46  
1,000 PCS / CTN.  
CTN. SIZE (mm)  
525 x 490 x 230  
2.09 CU.FT.  
0.06 CBM  
4.9 KG / 10.8 LBS



**STRAW SLOT**  
PLALID-F98SS  
98 x 10  
1,000 PCS / CTN.  
CTN. SIZE (mm)  
532 x 432 x 232  
1.88 CU.FT.  
0.05 CBM  
3.8 KG / 8.3 LBS



**SIP LID**  
PLALID-S98  
98 x 23  
1,000 PCS / CTN.  
CTN. SIZE (mm)  
530 x 426 x 235  
1.87 CU.FT.  
0.05 CBM  
4.4 KG / 9.6 LBS



**32oz**  
PLAC32-D107  
108 x 75 x 174  
500 PCS / CTN.  
CTN. SIZE (mm)  
565 x 455 x 430  
3.90 CU.FT.  
0.11 CBM  
14.1 KG / 31.1 LBS



**STRAW SLOT**  
PLALID-F107SS  
107 x 11  
500 PCS / CTN.  
CTN. SIZE (mm)  
560 x 240 x 240  
1.14 CU.FT.  
0.03 CBM  
2.3 KG / 5.1 LBS



These fresh view bowls are specifically designed to showcase your bakery, deli, produce and “grab-and-go” items.

These bowls are the perfect complement for pre-packed or fresh salads and cut fruit.

The no-spill lid is also perfect for stacking. Available in bulk or combo pack.

**175mm Dia.**



**18oz**  
PLASB18-D175  
175 x 50 x 20

150 SETS / CTN.  
CTN. SIZE (mm)  
543 x 188 x 565  
2.04 CU.FT. / 0.06 CBM

300 SETS / CTN.  
CTN. SIZE (mm)  
575 x 533 x 376  
4.07 CU.FT. / 0.12 CBM

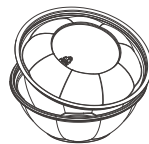

**24oz**  
PLASB24-D175  
175 x 62 x 20

150 SETS / CTN.  
CTN. SIZE (mm)  
543 x 188 x 583  
2.10 CU.FT. / 0.06 CBM

300 SETS / CTN.  
CTN. SIZE (mm)  
603 x 533 x 376  
4.27 CU.FT. / 0.12 CBM

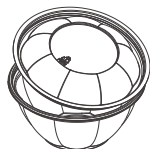

**32oz**  
PLASB32-D175  
175 x 83 x 20

150 SETS / CTN.  
CTN. SIZE (mm)  
543 x 188 x 600  
2.16 CU.FT. / 0.06 CBM

300 SETS / CTN.  
CTN. SIZE (mm)  
630 x 533 x 376  
4.46 CU.FT. / 0.13 CBM

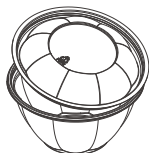

**48oz**  
PLASB48-D175  
175 x 112 x 20

150 SETS / CTN.  
CTN. SIZE (mm)  
543 x 188 x 620  
2.23 CU.FT. / 0.06 CBM

300 SETS / CTN.  
CTN. SIZE (mm)  
650 x 533 x 376  
4.60 CU.FT. / 0.13 CBM

**225mm Dia.**

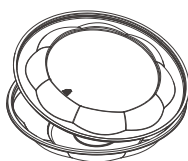

**40oz**  
PLASB40-D255  
225 x 50 x 25

100 SETS / CTN.  
CTN. SIZE (mm)  
520 x 276 x 390  
1.98 CU.FT. / 0.06 CBM

200 SETS / CTN.  
CTN. SIZE (mm)  
521 x 500 x 542  
4.98 CU.FT. / 0.14 CBM

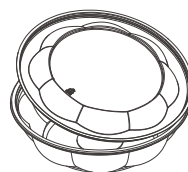

**64oz**  
PLASB64-D255  
225 x 73 x 25

100 SETS / CTN.  
CTN. SIZE (mm)  
520 x 276 x 445  
2.25 CU.FT. / 0.06 CBM

200 SETS / CTN.  
CTN. SIZE (mm)  
535 x 510 x 542  
5.22 CU.FT. / 0.15 CBM



# HEAVY DUTY MICROWAVE PP CONTAINERS

HEAT + COLD RESISTANCE

- 1 The dome style raised lids that increase the usable space.
- 2 Secure fit to eliminate spills. Audible click closure indicates a secure lock.
- 3 Allow steam to escape which is especially important to prevent food from getting soggy or mushy.
- 4 Recyclable black PP base with clear see-thru lid.



Heat tolerance up to 230° F / 110° C in the microwave oven or display case.

## ROUND TYPE COMBO PACK

	<b>16oz</b> ITEM NO. 8311 SIZE: Ø 6 x 2 in.	<b>w/ PP LID COMPO</b> 150 SETS / CTN. CTN. SIZE 473 x 158 x 515mm 1.36 CU.FT. / 0.04 CBM 6.0 KG / 13.23 LBS	<b>w/ OPS LID COMPO</b> 150 SETS / CTN. CTN. SIZE 473 x 158 x 470mm 1.24 CU.FT. / 0.04 CBM 4.7 KG / 10.36 LBS
	<b>24oz</b> ITEM NO. 8377 SIZE: Ø 7 x 1.5 in.	<b>w/ PP LID COMPO</b> 150 SETS / CTN. CTN. SIZE 561 x 182 x 495mm 1.78 CU.FT. / 0.05 CBM 7.50 KG / 16.53 LBS	<b>w/ OPS LID COMPO</b> 150 SETS / CTN. CTN. SIZE 561 x 182 x 470mm 1.70 CU.FT. / 0.05 CBM 5.9 KG / 13.01 LBS
	<b>32oz</b> ITEM NO. 8399 SIZE: Ø 7 x 2 in.	<b>w/ PP LID COMPO</b> 150 SETS / CTN. CTN. SIZE 561 x 182 x 515mm 1.86 CU.FT. / 0.05 CBM 8.0 KG / 17.64 LBS	<b>w/ OPS LID COMPO</b> 150 SETS / CTN. CTN. SIZE 561 x 182 x 485mm 1.75 CU.FT. / 0.05 CBM 6.5 KG / 14.33 LBS
	<b>35oz</b> ITEM NO. 8337 SIZE: Ø 8 x 2 in.	<b>w/ PP LID COMPO</b> 150 SETS / CTN. CTN. SIZE 656 x 215 x 490mm 2.44 CU.FT. / 0.07 CBM 10.4 KG / 22.93 LBS	<b>w/ OPS LID COMPO</b> 150 SETS / CTN. CTN. SIZE 656 x 224 x 506mm 2.62 CU.FT. / 0.07 CBM 8.2 KG / 18.08 LBS
	<b>48oz</b> ITEM NO. 9999 SIZE: Ø 9 x 2 in.	<b>w/ PP LID COMPO</b> 150 SETS / CTN. CTN. SIZE 716 x 242 x 515mm 3.15 CU.FT. / 0.09 CBM 11.5 KG / 25.35 LBS	
	<b>39oz 3 Comp.</b> ITEM NO. 9333 SIZE: Ø 9 x 2 in.	<b>w/ PP LID COMPO</b> 150 SETS / CTN. CTN. SIZE 716 x 242 x 550mm 3.36 CU.FT. / 0.10 CBM 13.5 KG / 29.76 LBS	

These containers are made from heavy duty PP, designed to stand up to high temperatures for food service applications, also safe for freezer storage. With their sturdy construction, these containers will keep your food securely and reliably. It is a great way for holding a variety of items and heating up food without the hassle of switching containers. It's perfect for hot foods, stews, sauces, soups, salads or refrigerated foods. Freezer & dishwasher safe, reusable & recyclable, BPA & CFC free.

## RECTANGULAR TYPE COMBO PACK



**12oz**

ITEM NO. 8300

SIZE: 5.5 x 4.5 x 1.5 in.

**w/ PP LID COMPO**

150 SETS / CTN.

CTN. SIZE 382 x 158 x 497mm

1.06 CU.FT. / 0.03 CBM

6.0 KG / 13.23 LBS

**w/ OPS LID COMPO**

150 SETS / CTN.

CTN. SIZE 382 x 158 x 400mm

0.85 CU.FT. / 0.02 CBM

4.4 KG / 9.70 LBS



**16oz**

ITEM NO. 8316

SIZE: 7.25 x 5 x 1.5 in.

**w/ PP LID COMPO**

150 SETS / CTN.

CTN. SIZE 418 x 212 x 436mm

1.36 CU.FT. / 0.04 CBM

7.8 KG / 17.20 LBS

**w/ OPS LID COMPO**

150 SETS / CTN.

CTN. SIZE 418 x 212 x 352mm

1.10 CU.FT. / 0.03 CBM

6.1 KG / 13.45 LBS



**24oz**

ITEM NO. 8322

SIZE: 7.25 x 5 x 2 in.

**w/ PP LID COMPO**

150 SETS / CTN.

CTN. SIZE 418 x 212 x 446mm

1.40 CU.FT. / 0.04 CBM

8.4 KG / 18.52 LBS

**w/ OPS LID COMPO**

150 SETS / CTN.

CTN. SIZE 418 x 212 x 397mm

1.24 CU.FT. / 0.04 CBM

6.5 KG / 14.33 LBS



**26oz**

ITEM NO. 8366

SIZE: 8.5 x 6 x 1.5 in.

**w/ PP LID COMPO**

150 SETS / CTN.

CTN. SIZE 485 x 233 x 435mm

1.74 CU.FT. / 0.05 CBM

9.0 KG / 19.84 LBS

**w/ OPS LID COMPO**

150 SETS / CTN.

CTN. SIZE 485 x 233 x 358mm

1.43 CU.FT. / 0.04 CBM

7.1 KG / 15.65 LBS



**38oz**

ITEM NO. 8388

SIZE: 8.5 x 6 x 2 in.

**w/ PP LID COMPO**

150 SETS / CTN.

CTN. SIZE 485 x 233 x 445mm

1.78 CU.FT. / 0.05 CBM

10.0 KG / 22.05 LBS

**w/ OPS LID COMPO**

150 SETS / CTN.

CTN. SIZE 485 x 233 x 358mm

1.43 CU.FT. / 0.04 CBM

7.6 KG / 16.76 LBS



## SINGLE-WALL PAPER CUPS

VG single wall paper hot cups are made for serving hot beverages like coffee, tea, or cocoa.

Due to our state-of-the-art German forming machines, our cups feature a smooth rolled rim that ensures a leak proof lid fit.

We offered in a variety of sizes to suit multiple drinks and up to 6-color prints.



**80mm**  
3.15" Dia.



**8oz**

PHC08W-D80  
80 x 56 x 90  
1,000 PCS / CTN.  
CTN. SIZE (mm)  
416 x 334 x 440  
2.16 CU.FT.  
0.06 CBM  
9.1 KG / 20.0 LBS



**8oz PP LID Closeable**

PHCLID-D80B/W  
80 x 23  
1,000 PCS / CTN.  
CTN. SIZE (mm)  
410 x 310 x 340  
1.53 CU.FT.  
0.04 CBM  
3.7 KG / 8.2 LBS

**90mm**  
3.54" Dia.



**10oz**

PHC10W-D90  
90 x 62 x 94  
1,000 PCS / CTN.  
CTN. SIZE (mm)  
460 x 370 x 431  
2.59 CU.FT.  
0.07 CBM  
10.3 KG / 22.8 LBS



**12oz**

PHC12W-D90  
90 x 60 x 111  
1,000 PCS / CTN.  
CTN. SIZE (mm)  
460 x 366 x 537  
3.19 CU.FT.  
0.09 CBM  
11.5 KG / 25.4 LBS



**16oz**

PHC16W-D90  
90 x 59 x 134  
1,000 PCS / CTN.  
CTN. SIZE (mm)  
456 x 376 x 542  
3.28 CU.FT.  
0.09 CBM  
13.9 KG / 30.6 LBS



**20oz**

PHC20W-D90  
90 x 63 x 150  
600 PCS / CTN.  
CTN. SIZE (mm)  
460 x 280 x 570  
2.59 CU.FT.  
0.07 CBM  
9.8 KG / 21.7 LBS

All single and double wall paper cups share common lids



**10-20oz PP LID**

PHCLID-D90B/W  
90 x 20  
1,000 PCS / CTN.  
CTN. SIZE (mm)  
480 x 384 x 295  
1.92 CU.FT.  
0.06 CBM  
5.1 KG / 11.3 LBS



## DOUBLE-WALL PAPER CUPS

VG double-wall paper cup provides excellent heat insulation effects. The built-in thermal layer protects hands from heat and keeps drinks at appropriate temperature, and the outside of the cup comfortable to hold. The form-fitted sealing lid keeps beverages hotter longer and security.

## Comfortable

Distinguishingly smooth outer wrap makes for a perfect surface to print clear and unambiguous artwork.

Built-in thermal layer makes the outer surface smoothly & comfortable handhold feel and tactile impression for customers.

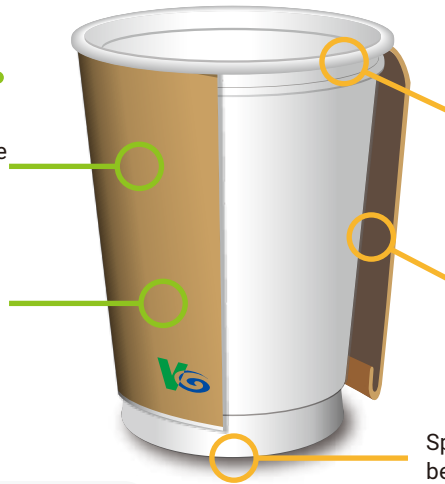

## Sturdy & Durable

Our secure and form-fitting lid creates a superior sealed barrier which helps prevent leaks.

The inner air space helps conserve heat within the contents of the cup, as well as maintaining a cool to the touch outer wall.

Special wider bottom design provides better stability for placement.

### MAXIMUM OUTSIDE SURFACE TEMPERATURE IN THE FIRST 3 MINUTES

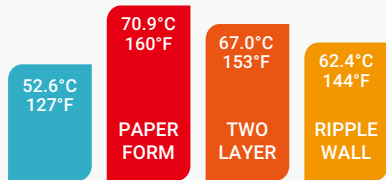

Hot water initial temperature 91°C / 196°F  
ROOM TEMPERATURE : 25.4°C / 77.7°F

### THE BEST CHOICE FOR THE SUSTAINABLE GROWTH OF THE PREMIUM BEVERAGE SEGMENT

Branded coffee companies & chains  
Fast casual restaurants or C-stores  
Hotels & lodging, airlines, and sports arenas



#### 8oz

DWPHC08W-D80-V  
80 x 53 x 96  
500 PCS / CTN.  
CTN. SIZE (mm)  
416 x 336 x 512  
2.53 CU.FT.  
0.07 CBM  
8.0 KG / 17.6 LBS



#### 10oz

DWPHC10W-D90-V  
90 x 60 x 96  
500 PCS / CTN.  
CTN. SIZE (mm)  
466 x 376 x 450  
2.78 CU.FT.  
0.08 CBM  
8.7 KG / 19.2 LBS



#### 12oz

DWPHC12W-D90-V  
90 x 61 x 114  
500 PCS / CTN.  
CTN. SIZE (mm)  
466 x 376 x 536  
3.32 CU.FT.  
0.09 CBM  
10.3 KG / 22.7 LBS



#### 16oz

DWPHC16W-D90-V  
90 x 60 x 139  
500 PCS / CTN.  
CTN. SIZE (mm)  
466 x 376 x 590  
3.65 CU.FT.  
0.10 CBM  
11.9 KG / 26.2 LBS



#### 20oz

DWPHC20W-D90-V  
90 x 56 x 164  
500 PCS / CTN.  
CTN. SIZE (mm)  
467 x 476 x 720  
5.54 CU.FT.  
0.16 CBM  
14.5 KG / 26.2 LBS

All single and double wall paper cups share common lids



#### 8oz PP LID Closeable

PHCLID-D80B/W  
80 x 23  
1,000 PCS / CTN.  
CTN. SIZE (mm)  
410 x 310 x 340  
1.51 CU.FT.  
0.04 CBM  
3.7 KG / 8.16 LBS



#### 10-20oz PP LID

PHCLID-D90B/W  
90 x 20  
1,000 PCS / CTN.  
CTN. SIZE (mm)  
480 x 384 x 295  
1.92 CU.FT.  
0.06 CBM  
5.1 KG / 11.3 LBS



## PAPER COLD CUPS

Whatever your beverage of choice, soda, juice, mixed drink or iced tea, VG paper cold cups are your best option. The double poly coating provides superior water resistance and high-gloss graphics capabilities. The combination of fresh wood fiber paper board and our state-of-the-art German machinery make for strong cup sidewalls and smooth rims for a leak-resistant lid fit. We offered in a variety of sizes to suit multiple drinks and up to 6-color prints.



## GENERIC / CUSTOM



### 7oz

PCC07W-D73  
73 x 51 x 81  
2,000 PCS / CTN.  
CTN. SIZE (mm)  
596 x 376 x 406  
3.21 CU.FT. / 0.09 CBM  
10.7 KG / 23.7 LBS



### 9oz

PCC09W-D75  
75 x 52 x 97  
2,000 PCS / CTN.  
CTN. SIZE (mm)  
636 x 406 x 412  
3.76 CU.FT. / 0.11 CBM  
13.9 KG / 30.7 LBS



### 12oz 90mm Dia.

PCC12W-D90  
90 x 61 x 95  
1,000 PCS / CTN.  
CTN. SIZE (mm)  
460 x 370 x 421  
2.53 CU.FT. / 0.07 CBM  
9.3 KG / 20.6 LBS



### 14oz

PCC14W-D90  
90 x 59 x 112  
1,000 PCS / CTN.  
CTN. SIZE (mm)  
460 x 366 x 520  
3.09 CU.FT. / 0.09 CBM  
10.6 KG / 23.3 LBS



### 16oz

PCC16W-D90  
90 x 61 x 127  
1,000 PCS / CTN.  
CTN. SIZE (mm)  
452 x 372 x 524  
3.11 CU.FT. / 0.09 CBM  
11.7 KG / 25.9 LBS



### 22oz

PCC22W-D90  
90 x 61 x 168  
1,000 PCS / CTN.  
CTN. SIZE (mm)  
460 x 370 x 612  
3.68 CU.FT. / 0.10 CBM  
14.8 KG / 32.7 LBS



### 32oz

PCC32W-D103  
103 x 71 x 177  
600 PCS / CTN.  
CTN. SIZE (mm)  
536 x 430 x 480  
3.91 CU.FT. / 0.11 CBM  
14.2 KG / 31.3 LBS



### 12-22oz PET LID

PCCLIDPET-D90  
90 x 8  
1,000 PCS / CTN.  
CTN. SIZE (mm)  
470 x 325 x 390  
2.10 CU.FT. / 0.06 CBM  
3.3 KG / 6.6 LBS



### 12-22oz PS LID

PCCLIDPS-F90  
90 x 7  
2,000 PCS / CTN.  
CTN. SIZE (mm)  
472 x 380 x 482  
3.05 CU.FT. / 0.09 CBM  
4.1 KG / 9.0 LBS



### 12-22oz PET LID

PCCLIDPET-F90  
90 x 8  
1,000 PCS / CTN.  
CTN. SIZE (mm)  
566 x 486 x 210  
2.04 CU.FT. / 0.06 CBM  
3.3 KG / 7.3 LBS



### 12-22oz PLA LID

PCCLIDPLA-F90  
90 x 8  
1,000 PCS / CTN.  
CTN. SIZE (mm)  
566 x 486 x 210  
2.04 CU.FT. / 0.06 CBM  
3.3 KG / 7.3 LBS



### 32oz PS LID

PCCLIDPS-F103  
103 x 8  
1,200 PCS / CTN.  
CTN. SIZE (mm)  
450 x 400 x 340  
2.16 CU.FT. / 0.06 CBM  
3.4 KG / 7.5 LBS



### 32oz PET LID

PCCLIDPET-F103  
103 x 8  
1,000 PCS / CTN.  
CTN. SIZE (mm)  
580 x 240 x 410  
2.01 CU.FT. / 0.06 CBM  
3.5 KG / 7.6 LBS



**12 oz**

PCHC12P-D90  
 90 x 59 x 111  
 1,000 PCS / CTN.  
 CTN. SIZE (mm)  
 460 x 366 x 537  
 3.19 CU.FT.  
 0.09 CBM  
 10.5 KG / 23.2 LBS



**16 oz**

PCHC16P-D90  
 90 x 59 x 134  
 1,000 PCS / CTN.  
 CTN. SIZE (mm)  
 456 x 376 x 542  
 3.28 CU.FT.  
 0.09 CBM  
 14.5 KG / 32.0 LBS



**20 oz**

PCHC20P-D90  
 90 x 63 x 150  
 600 PCS / CTN.  
 CTN. SIZE (mm)  
 460 x 280 x 570  
 2.59 CU.FT.  
 0.07 CBM  
 9.8 KG / 21.7 LBS



**22 oz**

PCHC22P-D90  
 90 x 61 x 167  
 1,000 PCS / CTN.  
 CTN. SIZE (mm)  
 460 x 370 x 625  
 3.76 CU.FT.  
 0.11 CBM  
 17.1 KG / 37.8 LBS

**PERFECT FOR  
 HOT & COLD  
 BEVERAGE**

These cups are protected with double-poly lining both inside and out. Ideal for both hot & cold drinks.

# DOUBLE-POLY LINED SINGLE WALL PAPER CUPS

# CUP HOLDERS

Material : PULP



**2 CUP**  
 192 x 110 x 34mm  
 600 PCS / CTN.  
 CTN. SIZE (mm)  
 585 x 410 x 228  
 1.93 CU.FT.  
 0.05 CBM  
 13.5 KG / 29.8 LBS



**4 CUP**  
 225 x 225 x 40mm  
 300 PCS / CTN.  
 CTN. SIZE (mm)  
 443 x 443 x 331  
 2.29 CU.FT.  
 0.06 CBM  
 13.5 KG / 29.8 LBS



# CUP SLEEVES

Material : BROWN / WHITE KRAFT



**FITS 8 OZ**  
 1,000 PCS / CTN.  
 CTN. SIZE (mm)  
 505 x 250 x 245  
 1.09 CU.FT.  
 0.03 CBM  
 4.8 KG / 10.6 LBS



**FITS 10~20 OZ**  
 1,000 PCS / CTN.  
 CTN. SIZE (mm)  
 560 x 262 x 278  
 1.34 CU.FT.  
 0.04 CBM  
 6.2 KG / 13.7 LBS

# PAPER BAGS

Material : BROWN / WHITE KRAFT

Available in White or Brown, can be printed upon for a variety of purposes and customized for different sizes.



**WHITE 80gsm**  
 180 x 80 x 240  
 400 PCS / CTN.  
 CTN. SIZE (mm)  
 390 x 270 x 340  
 1.26 CU.FT.  
 0.04 CBM  
 9.2 KG / 20.3 LBS



**WHITE 100gsm**  
 220 x 120 x 300  
 400 PCS / CTN.  
 CTN. SIZE (mm)  
 510 x 320 x 370  
 1.96 CU.FT.  
 0.06 CBM  
 12.4 KG / 27.3 LBS



**BROWN 75gsm**  
 220 x 120 x 280  
 400 PCS / CTN.  
 CTN. SIZE (mm)  
 510 x 320 x 370  
 1.84 CU.FT.  
 0.05 CBM  
 12.2 KG / 26.9 LBS



**BROWN 75gsm**  
 240 x 120 x 300  
 400 PCS / CTN.  
 CTN. SIZE (mm)  
 510 x 320 x 370  
 2.13 CU.FT.  
 0.06 CBM  
 13.0 KG / 28.7 LBS



**BROWN 114gsm**  
 280 x 320 x 120  
 300 PCS / CTN.  
 CTN. SIZE (mm)  
 590 x 340 x 300  
 2.12 CU.FT.  
 0.06 CBM  
 15.0 KG / 33.1 LBS



# STANDARD PAPER FOOD CONTAINERS





IDEAL FOR BOTH **HOT** & **COLD** FOODS  
 - OATMEAL, SOUP, ICE CREAM, & YOGURT.

VG paper food containers can be used with hot soup or pasta but also for cold and even frozen desserts such as ice cream and yogurt. Double poly coating provides moisture-resistant and grease-proof that locks in flavor and freshness. Suitable for restaurants, delis & supermarkets, ice cream & frozen yogurt shops.

Various sizes ranging in white and up to 6-color custom print, each with a tight-fit PP flat lid or PET dome lid option.



**4oz**

YGTC04W-D75  
 75 x 62 x 47  
 1,000 PCS / CTN.  
 CTN. SIZE (mm)  
 386 x 312 x 416  
 1.77 CU.FT.  
 0.05 CBM  
 4.9 KG / 10.8 LBS



**6oz**

YGTC06W-D96  
 96 x 81 x 49  
 1,000 PCS / CTN.  
 CTN. SIZE (mm)  
 496 x 398 x 524  
 3.65 CU.FT.  
 0.10 CBM  
 8.3 KG / 18.3 LBS



**8oz**

YGTC08W-D95  
 95 x 73 x 61  
 1,000 PCS / CTN.  
 CTN. SIZE (mm)  
 496 x 398 x 380  
 2.65 CU.FT.  
 0.07 CBM  
 8.4 KG / 18.6 LBS



**12oz**

YGTC12W-D101  
 101 x 70 x 80  
 1,000 PCS / CTN.  
 CTN. SIZE (mm)  
 520 x 420 x 446  
 3.44 CU.FT.  
 0.10 CBM  
 9.5 KG / 21.0 LBS



**16oz**

YGTC16W-D112  
 102 x 90 x 84  
 1,000 PCS / CTN.  
 CTN. SIZE (mm)  
 570 x 458 x 502  
 4.63 CU.FT.  
 0.13 CBM  
 12.6 KG / 27.9 LBS



**20oz**

YGTC20W-D126  
 126 x 105 x 76  
 600 PCS / CTN.  
 CTN. SIZE (mm)  
 520 x 390 x 456  
 3.26 CU.FT.  
 0.09 CBM  
 8.6 KG / 18.9 LBS



**20oz**

YGTC20W-D142  
 142 x 115 x 65  
 600 PCS / CTN.  
 CTN. SIZE (mm)  
 570 x 434 x 582  
 5.08 CU.FT.  
 0.14 CBM  
 9.7 KG / 21.4 LBS



**24oz**

YGTC24W-D142  
 142 x 115 x 75  
 600 PCS / CTN.  
 CTN. SIZE (mm)  
 570 x 434 x 696  
 6.08 CU.FT.  
 0.17 CBM  
 10.8 KG / 23.8 LBS

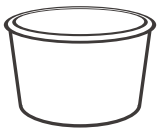

**30oz**

YGTC30W-D142  
 142 x 112 x 84  
 600 PCS / CTN.  
 CTN. SIZE (mm)  
 570 x 434 x 601  
 5.25 CU.FT.  
 0.15 CBM  
 10.7 KG / 23.7 LBS

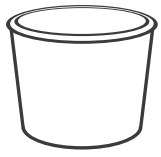

**32oz**

YGTC32W-D142  
 142 x 109 x 105  
 600 PCS / CTN.  
 CTN. SIZE (mm)  
 570 x 434 x 614  
 5.36 CU.FT.  
 0.15 CBM  
 12.4 KG / 27.3 LBS



**4oz PET LID**  
 YGTCLID-F76  
 76 x 11  
 1000 PCS / CTN.  
 CTN. SIZE (mm)  
 410 x 330 x 230  
 1.10 CU.FT. / 0.03 CBM  
 2.1 KG / 4.6 LBS



**4oz PET LID**  
 YGTCLID-D76  
 76 x 34  
 1,000 PCS / CTN.  
 CTN. SIZE (mm)  
 480 x 415 x 180  
 1.27 CU.FT. / 0.04 CBM  
 2.9 KG / 6.5 LBS



**6oz PP LID**  
 DPPFCF16T-PPL  
 96 x 9  
 1,000 PCS / CTN.  
 CTN. SIZE (mm)  
 505 x 290 x 405  
 2.09 CU.FT. / 0.06 CBM  
 3.5 KG / 7.7 LBS

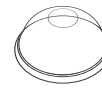

**6oz PET LID**  
 YGTCLID-D96  
 96 x 47  
 1,000 PCS / CTN.  
 CTN. SIZE (mm)  
 560 x 535 x 230  
 2.43 CU.FT. / 0.07 CBM  
 5.4 KG / 11.8 LBS



**8oz PP LID**  
 YGTCLID-F95  
 95 x 10  
 1,000 PCS / CTN.  
 CTN. SIZE (mm)  
 500 x 325 x 400  
 2.29 CU.FT. / 0.06 CBM  
 3.5 KG / 7.7 LBS



**8oz PET LID**  
 YGTCLID-D95  
 95 x 45  
 1,000 PCS / CTN.  
 CTN. SIZE (mm)  
 560 x 520 x 220  
 2.26 CU.FT. / 0.06 CBM  
 5.0 KG / 11.1 LBS



**12oz PP LID**  
 YGTCLID-F101  
 101 x 10  
 1,000 PCS / CTN.  
 CTN. SIZE (mm)  
 545 x 312 x 425  
 2.55 CU.FT. / 0.07 CBM  
 4.0 KG / 8.8 LBS

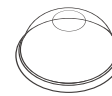

**12oz PET LID**  
 YGTCLID-D101  
 101 x 47  
 1,000 PCS / CTN.  
 CTN. SIZE (mm)  
 580 x 550 x 225  
 2.53 CU.FT. / 0.07 CBM  
 5.6 KG / 12.4 LBS



**16oz PP LID**  
 YGTCLID-F112  
 112 x 9  
 1,000 PCS / CTN.  
 CTN. SIZE (mm)  
 595 x 320 x 470  
 3.16 CU.FT. / 0.09 CBM  
 4.5 KG / 9.9 LBS

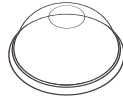

**16oz PET LID**  
 YGTCLID-D112  
 112 x 47  
 1,000 PCS / CTN.  
 CTN. SIZE (mm)  
 590 x 480 x 330  
 3.30 CU.FT. / 0.09 CBM  
 6.7 KG / 14.8 LBS

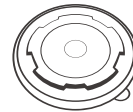

**20oz PP LID**  
 YGTCLID-F126  
 126 x 9  
 600 PCS / CTN.  
 CTN. SIZE (mm)  
 530 x 330 x 395  
 2.44 CU.FT. / 0.07 CBM  
 4.0 KG / 8.8 LBS

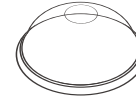

**20oz PET LID**  
 YGTCLID-D126  
 126 x 50  
 600 PCS / CTN.  
 CTN. SIZE (mm)  
 555 x 420 x 290  
 2.39 CU.FT. / 0.07 CBM  
 5.2 KG / 11.4 LBS

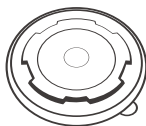

**20-32oz  
 PP LID**  
 YGTCLID-F142  
 142 x 9  
 600 PCS / CTN.  
 CTN. SIZE (mm)  
 595 x 315 x 440  
 2.91 CU.FT.  
 0.08 CBM  
 4.5 KG / 9.9 LBS

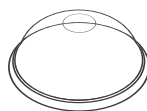

**20-32oz  
 PET LID**  
 YGTCLID-D142  
 142 x 46  
 600 PCS / CTN.  
 CTN. SIZE (mm)  
 588 x 450 x 325  
 3.04 CU.FT.  
 0.09 CBM  
 6.3 KG / 13.9 LBS



**20-32oz  
 PP TRAY**  
 YGTCHINS-F142  
 142 x 50  
 300 PCS / CTN.  
 CTN. SIZE (mm)  
 602 x 374 x 462  
 3.67 CU.FT.  
 0.10 CBM  
 6.1 KG / 13.5 LBS



PERFECT FOR  
HOT & COLD  
FOODS

## HEAVY WEIGHT PAPER FOOD CONTAINERS

VG heavy weight paper food containers are perfect fit for both hot and cold applications.

Made with high quality paperboard and double-sided poly coated for extra strength, make these containers more rigid, durable, and versatile.

Ideal for hot take-out items such as soup or for storing ice cream in the freezer. Great for delis, salad bars, ice cream and frozen yogurt shops, fairs and more.





IDEAL FOR BOTH  
**HOT & COLD** FOODS  
 - OATMEAL, SOUP,  
 ICE CREAM, & YOGURT.

Available in 8, 12, 16 Tall  
 to 32 oz and come with  
 a tight-fit vented PP flat lid.  
 8, 12 & 16 Tall share one lid  
 to reduce storage space  
 and inventory cost.

Offered in white and  
 up to 6-color print.



**8oz**  
 DPPFCW08-B  
 96 x 79 x 61  
 1,000 PCS / CTN.  
 CTN. SIZE (mm)  
 496 x 398 x 432  
 3.01 CU.FT.  
 0.09 CBM  
 10.2 KG / 22.5 LBS



**12oz**  
 DPPFCW12-B  
 96 x 77 x 73  
 1,000 PCS / CTN.  
 CTN. SIZE (mm)  
 496 x 398 x 446  
 3.11 CU.FT.  
 0.09 CBM  
 11.2 KG / 24.7 LBS

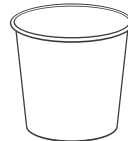

**16oz Tall**  
 DPPFCW16T-B  
 96 x 71 x 100  
 1,000 PCS / CTN.  
 CTN. SIZE (mm)  
 496 x 398 x 476  
 3.32 CU.FT.  
 0.09 CBM  
 13.4 KG / 29.5 LBS

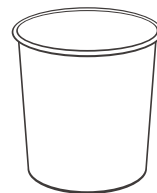

**32oz**  
 DPPFCW32-B  
 115 x 86 x 136  
 500 PCS / CTN.  
 CTN. SIZE (mm)  
 596 x 466 x 378  
 3.71 CU.FT.  
 0.10 CBM  
 11.0 KG / 24.2 LBS



**8-12-16oz PP LID**  
 DPPFCF16T-PPL  
 96 x 9  
 1,000 PCS / CTN.  
 CTN. SIZE (mm)  
 505 x 290 x 405  
 2.09 CU.FT.  
 0.06 CBM  
 3.5 KG / 7.7 LBS

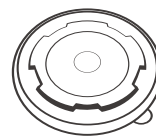

**32oz PP LID**  
 DPPFCF32-PPL  
 115 x 9  
 500 PCS / CTN.  
 CTN. SIZE (mm)  
 600 x 310 x 245  
 1.61 CU.FT.  
 0.05 CBM  
 2.5 KG / 5.5 LBS



# SQUARE KRAFT PAPER FOOD BOX

PERFECT FOR  
HOT & COLD  
FOODS

VG square kraft paper food box with recyclable double PE coating paper is suitable for a variety of cold and hot foods applications. The square design and anti-fog PET lid create clean and space-saving look for displaying at supermarkets, food shops, grab and go stores.

### Durability



The double PE coating makes the kraft paper food box waterproof and anti-grease.

### Displayable



The anti-fog clear lid and square design provide the food visibility, freshness for display and food delivery security.

### Multipurpose



Perfect for daily use, outdoor picnic, family party, travel etc.

### Multiple sizes



Ranging from 240ml to 1920ml, it is suitable for salad, sandwiches, steak, spaghetti etc.

### Recyclable



The square kraft paper food box is 100% recyclable.



#### 5" 240ml

G0240  
127 x 127 x 25  
600 PCS / CTN.  
CTN. SIZE (mm)  
410 x 275 x 450  
1.79 CU.FT.  
0.05 CBM  
5.3 KG / 11.8 LBS

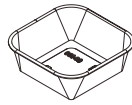

#### 5" 480ml

G0480  
127 x 127 x 45  
600 PCS / CTN.  
CTN. SIZE (mm)  
410 x 275 x 455  
1.81 CU.FT.  
0.05 CBM  
7.2 KG / 15.9 LBS

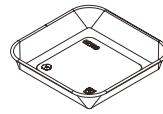

#### 7" 720ml

G0720  
178 x 178 x 31  
300 PCS / CTN.  
CTN. SIZE (mm)  
562 x 375 x 275  
2.05 CU.FT.  
0.06 CBM  
5.4 KG / 12.0 LBS

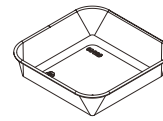

#### 7" 960ml

G0960  
178 x 178 x 42  
300 PCS / CTN.  
CTN. SIZE (mm)  
562 x 375 x 295  
2.19 CU.FT.  
0.06 CBM  
7.0 KG / 15.4 LBS

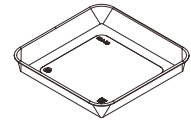

#### 9" 1440ml

G1440  
228 x 228 x 34  
300 PCS / CTN.  
CTN. SIZE (mm)  
485 x 485 x 380  
3.16 CU.FT.  
0.09 CBM  
9.6 KG / 21.1 LBS

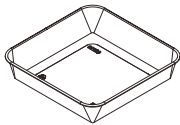

#### 9" 1920ml

G1920  
228 x 228 x 47  
300 PCS / CTN.  
CTN. SIZE (mm)  
485 x 485 x 400  
3.32 CU.FT.  
0.09 CBM  
10.6 KG / 23.3 LBS

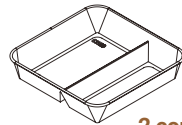

#### 9" 690ml/460ml

G1800  
228 x 228 x 47  
300 PCS / CTN.  
CTN. SIZE (mm)  
485 x 485 x 475  
3.94 CU.FT.  
0.11 CBM  
11.8 KG / 26.1 LBS

2 comp.

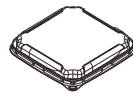

#### 5" Lid

GL05  
131 x 131 x 24  
600 PCS / CTN.  
CTN. SIZE (mm)  
560 x 265 x 415  
2.17 CU.FT.  
0.06 CBM  
5.6 KG / 12.3 LBS

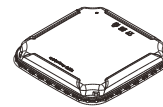

#### 7" Lid

GL07  
183 x 183 x 24  
300 PCS / CTN.  
CTN. SIZE (mm)  
560 x 280 x 358  
2.13 CU.FT.  
0.06 CBM  
5.1 KG / 11.3 LBS

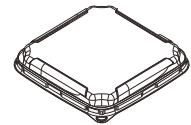

#### 9" Lid

GL09  
236 x 236 x 24  
300 PCS / CTN.  
CTN. SIZE (mm)  
495 x 440 x 495  
3.81 CU.FT.  
0.11 CBM  
8.9 KG / 19.6 LBS



# CUSTOM PRINTING

GET YOUR MESSAGE DIRECTLY INTO THE HANDS OF YOUR CUSTOMERS.



EASILY & EFFECTIVELY  
PROMOTE YOUR BUSINESS

Custom printing is the perfect solution to build your brand image and grow market awareness. It allows you to cost effectively advertise your company's brand - products, style and values - and provides a point of distinction for your brand in an otherwise saturated market. It is a portable billboard for your business right in your customers hands. It's an advantage that what we like to call "Brand In Hand".

Customize all your foodservice disposables – paper hot and cold cups, paper food containers, plastic drink cups, plastic round containers and cup sleeves.

## WE UNDERSTAND PRINTING



### PRINTING APPLICATION

We have world-class printing equipment. For plastic cups and containers, we have four 6-color Van Dam UV offset printing machines. For paper cups and containers, we have 8-color FLEXO machine and four German printing machines that print up to 5-colors.

### PRINTING SERVICE

We manage all design and print services in-house. We can recreate or modify your existing artwork or our designers can help you develop an entirely new brand concept. We can even create mock-ups so that you can see what the actual product will look like once artwork is finalized.

# 5 STEPS

**SIMPLE & EASY!**

# WE'RE HERE TO HELP

WHATEVER YOUR PRINTING NEEDS

01

Choose the cup or container size(s) you need. We offer a wide range of sizes on paper cold cups, paper hot cups – single or double wall, paper food containers, PET drink cups, PET round deli containers and PLA drink cups.

02

Choose up to 6-colors for your plastic cups / containers, 5-colors for your paper cups and containers and up to 4-colors for your customized PLA drink cups and cup sleeves.

03

Send us your artwork as an AI (Adobe Illustrator), EPS (Encapsulated PostScript) or PDF file. If electronic artwork is not available, send a sample of your cup or container and we will recreate the artwork by hand.

04

Once you have perfected your design, we will produce a digital file of the artwork for you to review and approve. We can also create a mock-up, if needed, for a minimal charge.

05

The printing process begins once the digital artwork file and/or mock-up has been approved and purchase order has been received. Custom printed products will be produced and delivered within our stated normal lead times.

**Our minimum order quantity for most custom prints is 50,000 pieces per sku.**

## ARTWORK REQUIREMENTS



### FILE FORMAT ▶ .AI

- Shapes and fonts must be outlined.
- Font size must be at least 8 pt bold.
- Artwork elements must be in layers, not merged.
- All images embedded and must be at least 300 dpi or higher.
- Define all colors CMYK or PANTONE® Solid Coated / Uncoated Color Code.
- PANTONE® Solid Coated Colors can be used, but not all colors can be achieved.

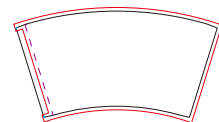

Available for all stock sizes.  
Please feel free to contact us  
for a template to get started.



If your artwork is designed by Photoshop or Corel Draw, please save it as a high resolution PDF, AI, or EPS file.

# UNDERSTANDING PRINTING METHODS



CYAN MAGENTA YELLOW BLACK

## 4-COLOR PROCESS PRINTING

Process printing refers to a process that uses 4 colors - Cyan (C), Magenta (M), Yellow (Y) and Black (B) to reproduce a wide range of colors by mixing the colors together as they are printed. This is known as CMYK process printing or 4-color process printing. A wide range of colors can be created with just 4 color printing plates so the number of reproducible colors is much higher than four. PANTONE® color codes can be provided as a final color reference, but not all PANTONE® colors can be reproduced.

## SPOT COLOR PRINTING



Spot color printing uses a color system of solid, pre-mixed colors, also known as PANTONE® colors. Spot colors are more accurate as you have already determined the color by its specific PANTONE® number. It is generally more economical if printing is kept to 3-colors or less.

Due to the use of food-grade inks, not all PANTONE® colors can be achieved. Also, spot colors are nearly impossible to replicate exactly on digital print devices such as color laser printers. Please note that the same color may appear differently on different raw materials.

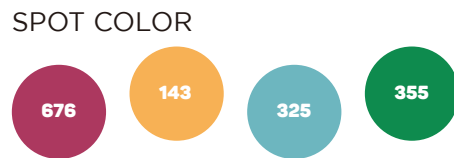
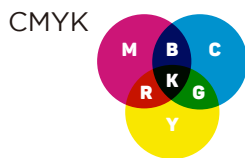
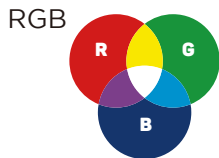

# PRINTING INFORMATION & DISCLAIMERS

### COLOR ACCURACY

When a PANTONE® color code is provided, finished products are expected to be within 2 PANTONE® colors, either up or down (refer to PANTONE® Solid color book). Due to food grade inks, not all PANTONE® color codes can be achieved, and any possible replacement is only at the manufacturer's discretion.

### INK ODOR

As a result of printing with food grade inks, a degree of ink odor should be expected in all custom printed products. Any possible replacement is only at the manufacturer's discretion.

### PRINT GAP

A ¼" gap is left between the leading edge of the design PET/PLA cups so that the design does not overlap.

### MINIMUM & LEAD TIMES

- All stated minimums apply for each size and/or design ordered. Minimums are subject to change at any time. Due to the nature of custom printed products, there may be a +/- 10% over/under run (variance between amount ordered and amount produced).
- Lead times are estimated and are not guaranteed.

### PLATE CHARGES

Plate charges will not be charged for reprint orders provided the existing plates are in good condition. If left unused, printing plates have a maximum life of 18 months. Customer will be notified if new plates will be necessary for their re-print orders and subsequently billed for the new plates.

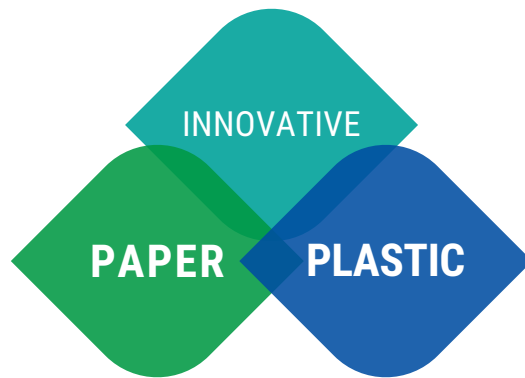

FULL LINE DISPOSABLE PACKAGING SOLUTIONS  
TO MEET THE EVOLVING DEMANDS



No. 17, Lugong Rd., Lukang Township,  
Changhua County 505, Taiwan R.O.C.

TEL: + 886 4 781 1589  
FAX: + 886 4 781 2078

[www.vigourpack.com](http://www.vigourpack.com)

© VigourPak and Vigour Plastic all rights reserved.