



INNOVATIVE BEVERAGE & FOOD
DISPOSABLE PACKAGING SOLUTIONS
FOR EVERY OCCASION

PRODUCT CATALOGUE



VIGOUR GROUP

www.vigourpack.com



Founded in 2002, VIGOUR GROUP is one of the leading disposable paper and plastic packaging manufacturers in Taiwan.

We focus on providing high quality, competitively priced paper and plastic foodservice disposables to the following market segments: C-stores, QSR, supermarkets, food processors, entertainment, airlines.

GLOBAL SERVICE

We cooperate with key customers in USA, Australia, Europe, Middle East, Asia, Latin America, and over twenty other countries, which has given us an important global footprint.



VIGOUR PACK and VIGOUR PLASTIC are both under the umbrella of it's parent holding company of VIGOUR GROUP.



Readily available materials include PET, PP, RPET, PLA, PBS, and paper boards, all of which are 100% FDA certified for food contact.



We provide convenient and efficient air, land and shipping routes. We are committed to give the best service and sales experience, no matter where you are located.

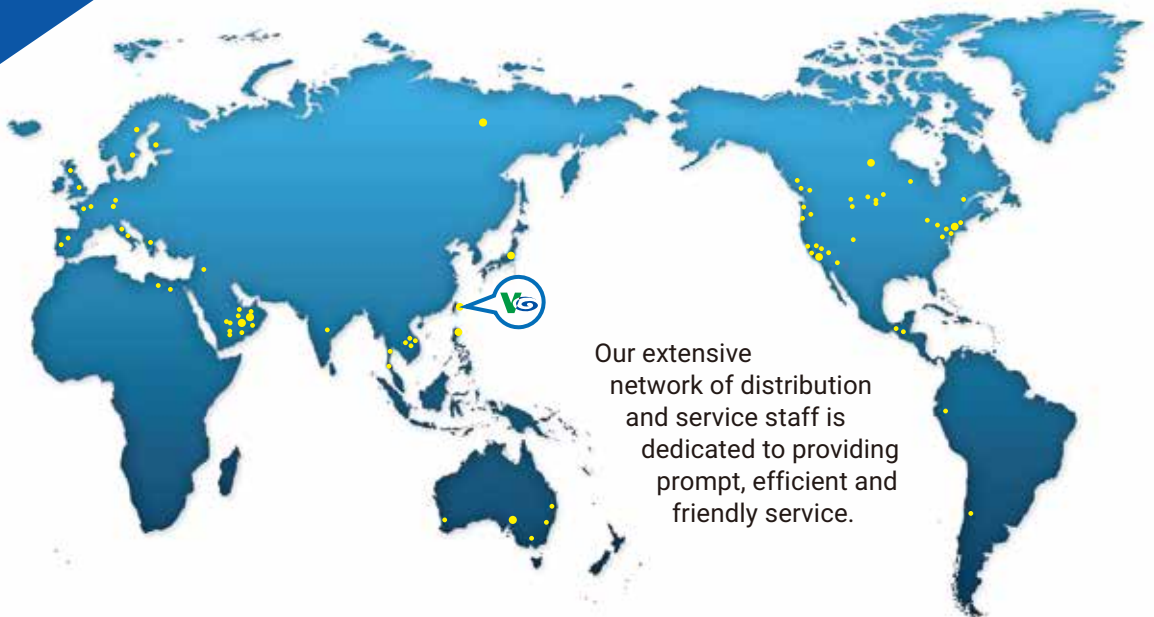

Our extensive network of distribution and service staff is dedicated to providing prompt, efficient and friendly service.

CERTIFICATION & CAPABILITIES

FSSC22000 Certifications make us Global Food Safety Initiative (GFSI) certified.

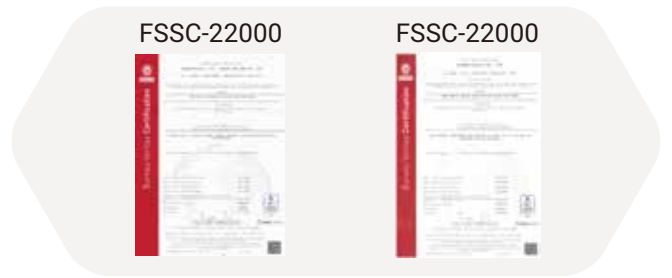

PLANT FACILITY

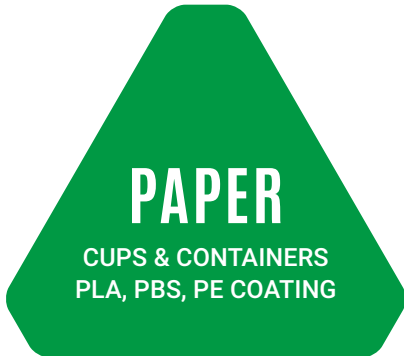

6 sets double wall paper cup forming machines.

36 German-made fully integrated and automated paper cup/container forming and packing lines.

Finished cups are auto-packed directly into sleeves to prevent any external contact. Film lamination to paper board capacity is over 5,000 tons per month.



9 EXTRUDERS, the monthly capacity of Eco-friendly material (RPET and PLA) products is over 400 tons each.

26 HIGH SPEED THERMOFORMERS which produce plastic cups (PET, PLA clear cups) and containers (PET, RPET, PLA, PP). Total capacity up to 200 million pcs per month.

PRINTING APPLICATION

5 German Heidelberg offset printing machines that print up to 6-colors and 8-color FLEXO machine for paper cups and containers.

4 6-color Van Dam UV offset printing machines for plastic cups and containers.

INDEX

PAGE NO.

PET TAMPER EVIDENT CONTAINER SERIES

BUT-N-LOC SERIES

- 08 HINGED LID CONTAINERS
- 11 7x6"HINGED LID CONTAINERS
- 12 HINGED SANDWICH WEDGE
- HINGED WRAP CONTANER & SMALL CONTAINER
- 13 9X13" 7CELL TRAY
- 14 SQUARE BOWLS
- 17 SQUARE DELI CONTAINERS
- 19 FLAT PANEL PARFAIT CUPS

TEAR OFF STRIP SERIES

- 22 HINGED LID CONTAINER
- 24 HINGED SQUARE CONTAINER
- 25 HINGED ROUND CONTAINER
- 26 HINGED TEAR OFF PARFAIT CUP

27 AUTO CLOSING MACHINE

PET CONTAINER SERIES

- 28 HINGED TYPE DELI CONTAINER
- 30 HINGED TYPE BAKERY CONTAINERS
- 32 HINGED TYPE BUTTER LETTUCE CONTAINERS
- 33 SINGLE / DOUBLE CLAMSHELL
- 34 4 COMP. SNACK CONTAINER
- 35 ROUND DELI CONTAINERS
- 37 ROUND PRODUCE CONTAINER
- 38 SALAD BOWLS
- 40 CAKE & PIE CONTAINERS

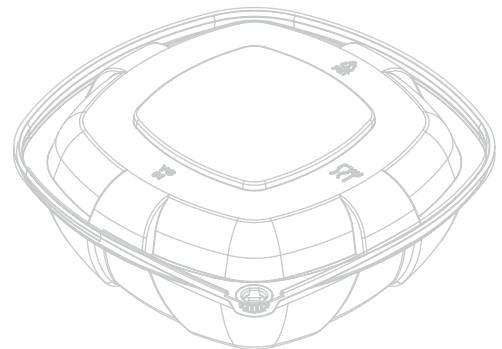
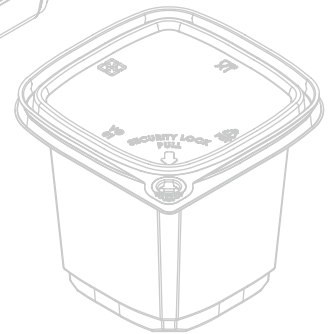
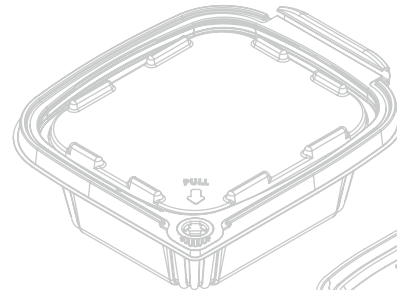
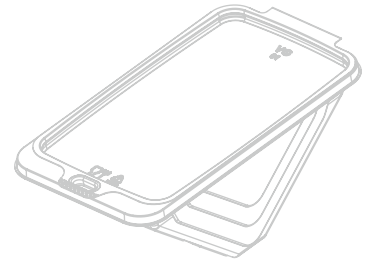



INDEX

PAGE NO.

42	PET CLEAR CUPS & LIDS
47	PLA BIOPLASTIC CLEAR CUPS & LIDS
51	PLA BIOPLASTIC SALAD BOWL
	PP CONTAINER SERIES
52	HEAVY DUTY PP CONTAINERS
	PAPER CUP SERIES
55	SINGLE WALL PAPER CUPS
57	DOUBLE WALL PAPER CUPS
59	PAPER COLD CUPS
61	DOUBLE-POLY LINED SINGLE WALL PAPER CUPS
62	HOLDERS, SLEEVES, BAGS
	PAPER FOOD CONTAINERS
63	STANDARD PAPER FOOD CONTAINERS
66	HEAVY WEIGHT PAPER FOOD CONTAINERS
68	SQUARE KRAFT PAPER FOOD BOX

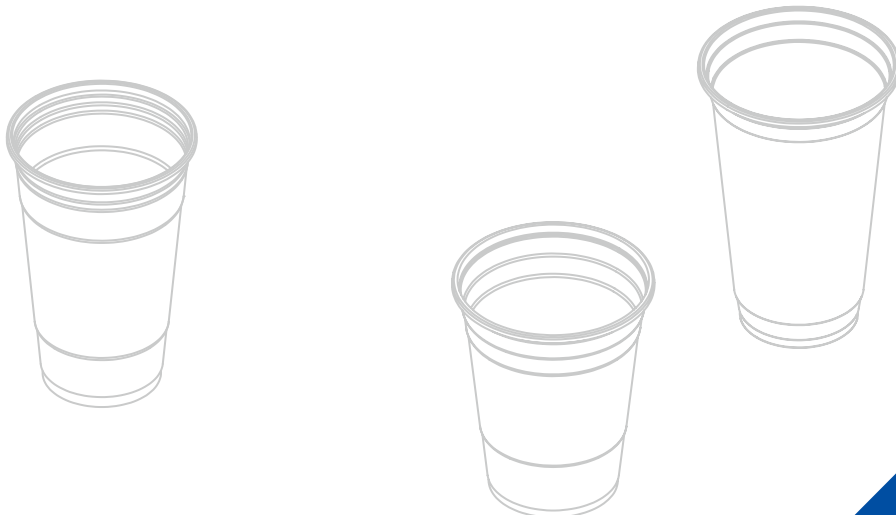

**PERFECT FOR
WET & DRY
READY TO EAT
FOODS**



TAMPER EVIDENT CONTAINER SERIES



- ✓ Available in RPET, Blended PET or PET
- ✓ High clarity and tight lid fit prevents leakage



 PATENTED BUTTON LOCK DESIGN

BUT-N-LOC[®]

SERIES

TEAR OFF

STRIP

SERIES



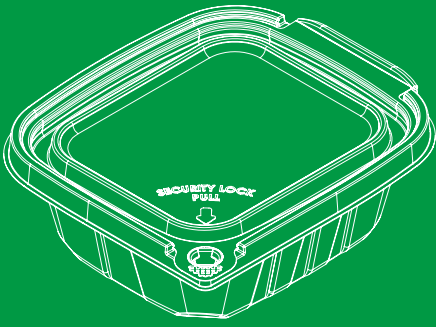

HINGED LID TYPE

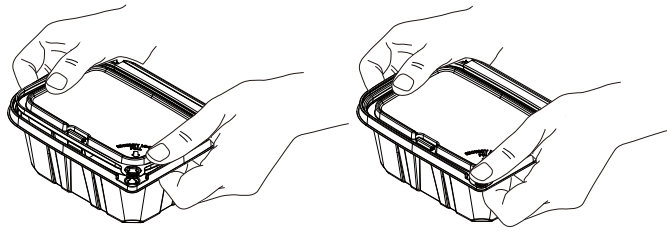

CLOSE THE LID

PUSH TO "LOC" BUTTON

CLOSE & OPEN

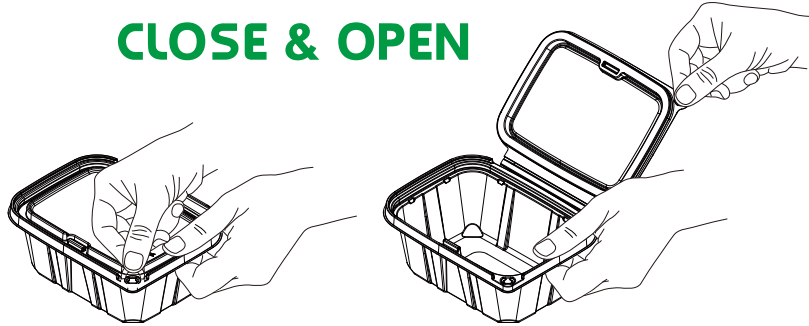

PULL THE TAB, BUTTON REMAINS

OPEN THE LID

 PATENTED BUTTON LOCK DESIGN

BUT-N-LOC®

The innovative tamper-resistant locking mechanism and seal ensures quality and eliminates the need for shrink bands and wrap labels.

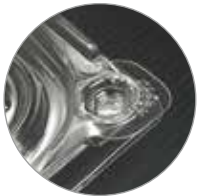

LOCKED



OPENED



NO LEAK LID

The button "Loc" tab fastens to the top of the base. If tampered with prior to purchase the **BUT-N-LOC®** button will not be connected to the tab and a clean hole in the tab will be evident. The engineered tight parameter seal promises a leak resistant experience.

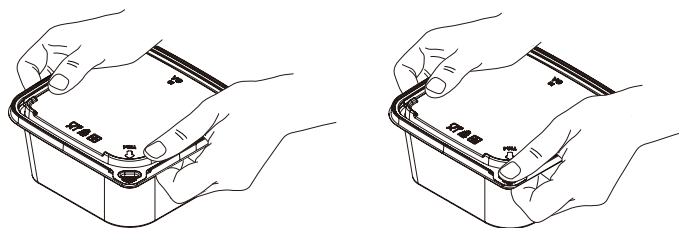

CLOSE THE LID

PUSH TO "LOC" BUTTON

CLOSE & OPEN

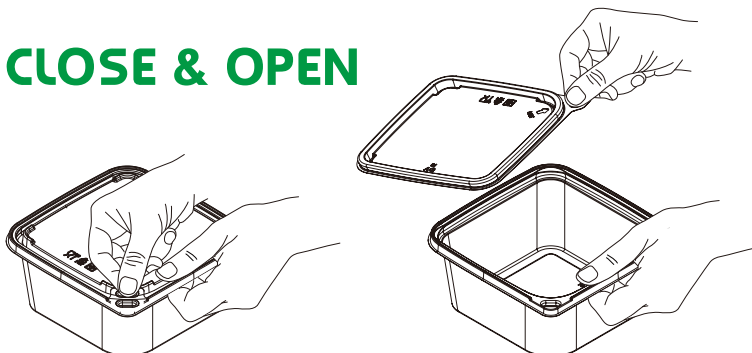

PULL THE TAB, BUTTON REMAINS

OPEN THE LID

2 PIECES TYPE

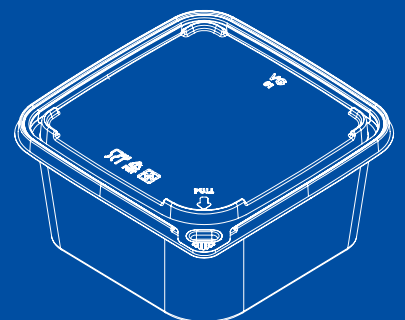



**BUT-N-LOC. TAMPER EVIDENT
HINGED LID CONTAINERS**

These patented hinged containers provides superior security and enhances the look of product with their crystal clear clarity. Perfect for cold pasta, fruit salad, leafy green salad, nuts, snack mixes, candy, desserts, and more. Ideal for delis, supermarkets, C-stores, and wholesale clubs.

It can be made from post-consumer recycled PET (rPET), provide environmental benefits and meet customer demand for more sustainable food packaging.



4oz

RPTTE4AD
110 x 90 x 32
780 PCS / CTN.
CTN. SIZE (mm)
560 x 465 x 419
3.85 CU.FT.
0.11 CBM
8.7 KG / 19.1 LBS



6oz

RPTTE6AD
110 x 90 x 44
780 PCS / CTN.
CTN. SIZE (mm)
565 x 465 x 431
4.00 CU.FT.
0.11 CBM
11.0 KG / 24.3 LBS



8oz

RPTTE8-R
147 x 128 x 39
240 PCS / CTN.
CTN. SIZE (mm)
527 x 314 x 329
1.92 CU.FT.
0.05 CBM
5.0 KG / 10.9 LBS



12oz

RPTTE12-R
147 x 128 x 51
240 PCS / CTN.
CTN. SIZE (mm)
527 x 314 x 342
2.00 CU.FT.
0.06 CBM
5.2 KG / 11.5 LBS



16oz

RPTTE16-R
147 x 128 x 65
240 PCS / CTN.
CTN. SIZE (mm)
527 x 314 x 356
2.08 CU.FT.
0.06 CBM
6.7 KG / 14.7 LBS

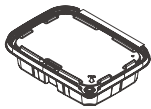

20oz

RPTTE20N-R
189 x 145 x 46
200 PCS / CTN.
CTN. SIZE (mm)
380 x 312 x 516
2.16 CU.FT.
0.06 CBM
7.3 KG / 16.2 LBS



20oz

RPTTE20A
189 x 147 x 51
200 PCS / CTN.
CTN. SIZE (mm)
605 x 395 x 345
2.91 CU.FT.
0.08 CBM
7.4 KG / 16.2 LBS



24oz

RPTTE24-R
189 x 145 x 57
200 PCS / CTN.
CTN. SIZE (mm)
380 x 312 x 528
2.21 CU.FT.
0.06 CBM
8.0 KG / 17.7 LBS



32oz

RPTTE32-R
189 x 146 x 70
200 PCS / CTN.
CTN. SIZE (mm)
380 x 312 x 540
2.26CU.FT.
0.06 CBM
8.6 KG / 19.0 LBS

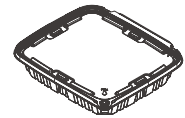

35oz

RPTTE35
223 x 201 x 46
134 PCS / CTN.
CTN. SIZE (mm)
455 x 425 x 455
3.11 CU.FT.
0.09 CBM
8.4 KG / 18.6 LBS

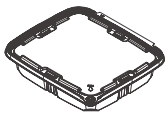

35oz SMOOTH WALL

RPTTE35SW-R
223 x 201 x 46
150 PCS / CTN.
CTN. SIZE (mm)
442 x 375 x 465
2.72 CU.FT.
0.08 CBM
9.3 KG / 20.5 LBS

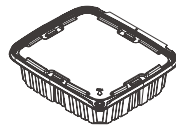

48oz

RPTTE48N
223 x 201 x 60
134 PCS / CTN.
CTN. SIZE (mm)
455 x 425 x 470
3.21 CU.FT.
0.09 CBM
9.0 KG / 19.8 LBS

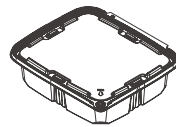

48oz SMOOTH WALL

RPTTE48SW-R
223 x 201 x 60
150 PCS / CTN.
CTN. SIZE (mm)
425 x 400 x 475
2.85 CU.FT.
0.08 CBM
9.9 KG / 21.9 LBS

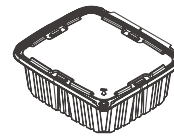

64oz

RPTTE64N
223 x 201 x 77
134 PCS / CTN.
CTN. SIZE (mm)
475 x 425 x 470
3.35 CU.FT.
0.09 CBM
10.5 KG / 23.1 LBS

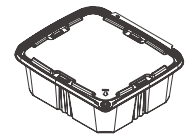

64oz SMOOTH WALL

RPTTE64SW-R
223 x 201 x 77
150 PCS / CTN.
CTN. SIZE (mm)
425 x 425 x 475
3.03 CU.FT.
0.09 CBM
11.6 KG / 25.6 LBS

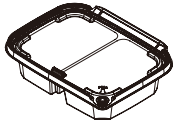

20oz 2 comp.

RPTTE20-2C
189 x 145 x 46
200 PCS / CTN.
CTN. SIZE (mm)
605 x 395 x 325
2.74 CU.FT.
0.08 CBM
8.0 KG / 17.7 LBS

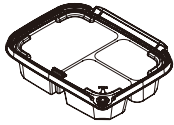

20oz 3 comp.

RPTTE20-3C
189 x 145 x 46
200 PCS / CTN.
CTN. SIZE (mm)
605 x 395 x 325
2.74 CU.FT.
0.08 CBM
8.0 KG / 17.7 LBS

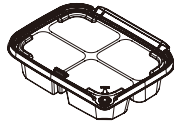

20oz 4 comp.

RPTTE20-4C
189 x 145 x 46
200 PCS / CTN.
CTN. SIZE (mm)
605 x 395 x 325
2.74 CU.FT.
0.08 CBM
8.0 KG / 17.7 LBS



BUT-N-LOC® TAMPER EVIDENT 2, 3, 4-COMPARTMENT CONTAINERS



BUT-N-LOC® TAMPER EVIDENT DOME LID 4 CELL CONTAINER

With 4 cell easily separate different foods and ensure that flavors don't mix.

Hinge design ensures the base and lid remain attached and the dome lid provides more capacity.

Great choice for carrying a variety of foods. Ideal for delis, C-stores, supermarkets, and wholesale clubs.

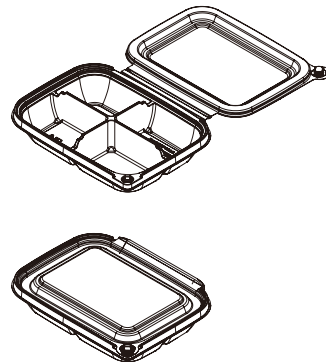

16oz

RPTTE16SP4C
189 x 143 x 38
460 PCS / CTN.
CTN. SIZE (mm)
609 x 392 x 584
4.92 CU.FT.
0.14 CBM
17.5 KG / 38.5 LBS



BUT-N-LOC® TAMPER EVIDENT 7x6" HINGED LID CONTAINERS

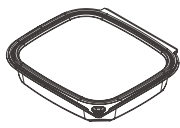

16oz

RPTTE76-16
181 x 163 x 34
348 PCS / CTN.
CTN. SIZE (mm)
557 x 340 x 576
3.85 CU.FT.
0.11 CBM
11.7 KG / 25.8 LBS



24oz

RPTTE76-24H
181 x 163 x 47
339 PCS / CTN.
CTN. SIZE (mm)
557 x 340 x 576
3.85 CU.FT.
0.11 CBM
13.7 KG / 30.2 LBS



24oz

RPTTE76-24HTV
181 x 163 x 55
339 PCS / CTN.
CTN. SIZE (mm)
557 x 340 x 576
3.85 CU.FT.
0.11 CBM
12.7 KG / 27.9 LBS

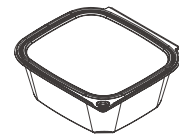

32oz

RPTTE76-32H
181 x 163 x 66
315 PCS / CTN.
CTN. SIZE (mm)
557 x 340 x 580
3.88 CU.FT.
0.11 CBM
14.4 KG / 31.7 LBS



RPTTE76-48JSV
**Fluid Catcher
Design**

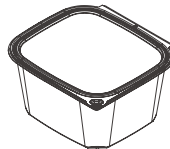

48oz

RPTTE76-48JSV
181 x 163 x 90
196 PCS / CTN.
CTN. SIZE (mm)
376 x 340 x 595
2.69 CU.FT.
0.08 CBM
12.7 KG / 27.9 LBS

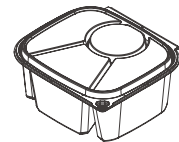

35oz 4 comp.

RPTTE76-4CTV
181 x 163 x 71
264 PCS / CTN.
CTN. SIZE (mm)
557 x 340 x 594
3.97 CU.FT.
0.11 CBM
17.5 KG / 38.6 LBS

VG's patented **But-N-Loc®** tamper evident hinged sandwich wedge is ideal for any sandwich shop, café, deli, or canteen.

The high-clarity material and contoured design ensures superb product visibility and attractive presentation for ready-made sandwich.

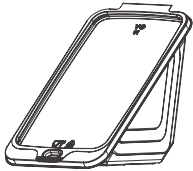

RPTTESW
 142 x 101 x 129
 250 PCS / CTN.
 CTN. SIZE (mm)
 525 x 395 x 360
 2.64 CU.FT.
 0.07 CBM
 7.2 KG / 15.9 LBS



BUT-N-LOC® TAMPER EVIDENT HINGED SANDWICH WEDGE



BUT-N-LOC® TAMPER EVIDENT HINGED WRAP CONTAINER & SMALL CONTAINER

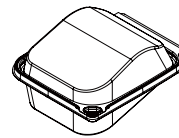

RPTTESWR
 143 x 130 x 56
 522 PCS / CTN.
 CTN. SIZE (mm)
 630 x 405 x 475
 4.28 CU.FT.
 0.12 CBM
 18.5 KG / 40.7 LBS

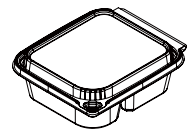

RPTTESWR-2C
 154 x 130 x 50
 330 PCS / CTN.
 CTN. SIZE (mm)
 405 x 323 x 567
 2.61 CU.FT.
 0.07 CBM
 10.1 KG / 22.3 LBS

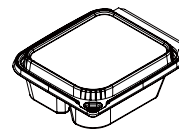

RPTTESWR-3C
 154 x 130 x 50
 330 PCS / CTN.
 CTN. SIZE (mm)
 405 x 323 x 567
 2.61 CU.FT.
 0.07 CBM
 10.1 KG / 22.3 LBS

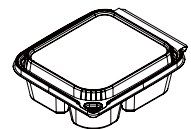

RPTTESWR-4C
 154 x 130 x 50
 330 PCS / CTN.
 CTN. SIZE (mm)
 405 x 323 x 567
 2.61 CU.FT.
 0.07 CBM
 10.1 KG / 22.3 LBS



BUT-N-LOC. TAMPER EVIDENT TRAY 9x13" 7 CELL

This 7 compartment container is perfect for leaf or pasta salads, cut vegetables, cut fruit, nuts, candies and other specialty foods.

Tight lid fit eliminates leakage, extends shelf life and product freshness and sturdy design allows stacking and bulk display in store.

Lid design ensure various food products remain separate in sealed compartments.

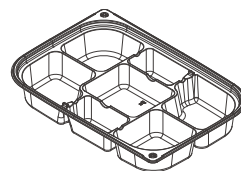

PTTE913-7C
 350 x 270 x 55
 100 PCS / CTN.
 CTN. SIZE (mm)
 518 x 365 x 455
 3.04 CU.FT. / 0.09 CBM
 7.6 KG / 16.7 LBS

VENTED LID

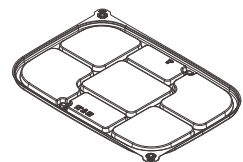

PTTE913-7CLID-V
 350 x 270 x 10
 100 PCS / CTN.
 CTN. SIZE (mm)
 503 x 365 x 420
 2.72 CU.FT. / 0.08 CBM
 7.3 KG / 16.1 LBS



BUT-N-LOC[®]

TAMPER EVIDENT SQUARE BOWLS



These patented clear square bowls are perfect for leaf or pasta salads, cut vegetables, cut fruit, nuts, candies and other specialty foods. Ideal for delis, supermarkets, wholesale clubs, and C-stores. Crystal clear lids give the consumer a clear view before buying and they are also crack-resistant and spill-proof to ensure safe and stable handling. Black base available in custom option.

5.0'' 127mm Dia.

Available in three ranges - 5" (small), 7.5" (Medium), and 9" (Large) in a variety of sizes and single, or 4 compartment options. The stack-ability of these square bowl may improve your shelf space utilization.



8oz

PTTESB5-08B
127 x 127 x 41
600 PCS / CTN.
CTN. SIZE (mm)
525 x 395 x 395
2.89 CU.FT.
0.08 CBM
7.3 KG / 16.1 LBS



12oz

PTTESB5-12B
127 x 127 x 56
600 PCS / CTN.
CTN. SIZE (mm)
525 x 395 x 400
2.93 CU.FT.
0.08 CBM
7.9 KG / 17.4 LBS

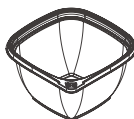

16oz

PTTESB5-16B
127 x 127 x 73
600 PCS / CTN.
CTN. SIZE (mm)
525 x 395 x 410
3.00 CU.FT.
0.08 CBM
9.1 KG / 20.1 LBS



FLAT LID

PTTESBFLID5B
127 x 127 x 8
600 PCS / CTN.
CTN. SIZE (mm)
495 x 375 x 350
2.29 CU.FT.
0.06 CBM
6.9 KG / 15.2 LBS

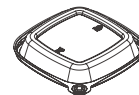

DOME LID

PTTESBDLD5B
127 x 127 x 21
600 PCS / CTN.
CTN. SIZE (mm)
495 x 375 x 340
2.23 CU.FT.
0.06 CBM
6.9 KG / 15.1 LBS

7.5"
191mm Dia.

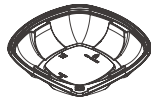

18oz
PTTESB75-18B
191 x 191 x 40
300 PCS / CTN.
CTN. SIZE (mm)
600 x 405 x 360
3.09 CU.FT. / .09 CBM
7.1 KG / 15.5 LBS

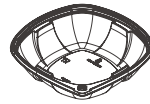

24oz
PTTESB75-24B
191 x 191 x 49
300 PCS / CTN.
CTN. SIZE (mm)
600 x 405 x 390
3.35 CU.FT. / 0.09 CBM
7.7 KG / 17.0 LBS

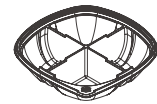

24oz 4 comp.
PTTESB75-24B-4C
191 x 191 x 49
300 PCS / CTN.
CTN. SIZE (mm)
600 x 405 x 390
3.35 CU.FT. / 0.09 CBM
7.7 KG / 17.0 LBS



32oz
PTTESB75-32B
191 x 191 x 62
300 PCS / CTN.
CTN. SIZE (mm)
600 x 405 x 400
3.43 CU.FT. / 0.10 CBM
8.0 KG / 17.7 LBS



48oz
PTTESB75-48B
191 x 191 x 86
300 PCS / CTN.
CTN. SIZE (mm)
600 x 405 x 435
3.73 CU.FT. / 0.11 CBM
9.0 KG / 19.8 LBS

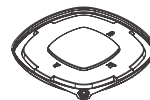

(18-48oz)
PTTESBFLID75B
181 x 181 x 10
300 PCS / CTN.
CTN. SIZE (mm)
565 x 385 x 355
2.73 CU.FT. / 0.08 CBM
6.4 KG / 14.0 LBS

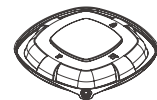

(18-48oz)
PTTESBDLID75B
181 x 181 x 25
300 PCS / CTN.
CTN. SIZE (mm)
565 x 385 x 350
2.69 CU.FT. / 0.08 CBM
6.4 KG / 14.0 LBS

9.0"
229mm Dia.



40oz
PTTESB9-40B
228 x 228 x 51
180 PCS / CTN.
CTN. SIZE (mm)
480 x 250 x 470
1.99 CU.FT. / 0.06 CBM
6.5 KG / 14.3 LBS

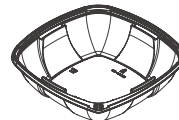

48oz
PTTESB9-48B
228 x 228 x 61
180 PCS / CTN.
CTN. SIZE (mm)
480 x 250 x 565
2.39 CU.FT. / 0.07 CBM
6.6 KG / 14.5 LBS



48oz 4 comp.
PTTESB9-48B-4C
228 x 228 x 61
180 PCS / CTN.
CTN. SIZE (mm)
480 x 250 x 565
2.39 CU.FT. / 0.07 CBM
6.6 KG / 14.5 LBS

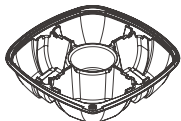

48oz 5 comp.
PTTESB9-48B-5C
228 x 228 x 61
180 PCS / CTN.
CTN. SIZE (mm)
480 x 250 x 563
2.38 CU.FT. / 0.07 CBM
7.1 KG / 15.7 LBS

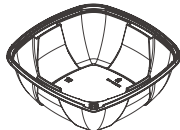

64oz
PTTESB9-64B
228 x 228 x 79
180 PCS / CTN.
CTN. SIZE (mm)
480 x 250 x 590
2.50 CU.FT. / 0.07 CBM
7.7 KG / 17.0 LBS

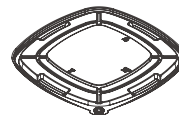

(40-64oz)
PTTESBFLID9B
218 x 218 x 12
180 PCS / CTN.
CTN. SIZE (mm)
480 x 250 x 475
2.01 CU.FT. / 0.06 CBM
6.0 KG / 13.1 LBS

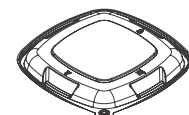

(40-64oz)
PTTESBDLID9B
218 x 218 x 25
180 PCS / CTN.
CTN. SIZE (mm)
480 x 250 x 455
1.93 CU.FT. / 0.05 CBM
5.9 KG / 13.0 LBS



**BUT-N-LOC[®] TAMPER EVIDENT
SQUARE DELI CONTAINERS**

These patented clear containers are available in five base sizes: 8, 12, 16, 24 & 32oz with one common lid fit for all sizes. A recessed lid allows for stable stacking to maximize shelf space. Available in bulk and combo (base+lid) packs.

Perfect for cold, ready-to-eat foods, like: pasta salad, cut fruit, nuts and candy. Ideal for delis, C-stores, supermarkets, and wholesale clubs.

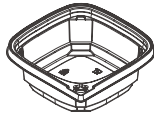

8oz 260ml

PTTESDC08
121 x 121 x 45
500 PCS / CTN.
CTN. SIZE (mm)
625 x 265 x 330
1.93 CU.FT.
0.05 CBM
7.0 KG / 15.5 LBS

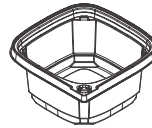

12oz 360ml

PTTESDC12
121 x 121 x 59
500 PCS / CTN.
CTN. SIZE (mm)
625 x 265 x 360
2.10 CU.FT.
0.06 CBM
9.1 KG / 20.1 LBS

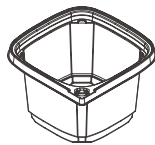

16oz 530ml

PTTESDC16
121 x 121 x 78
500 PCS / CTN.
CTN. SIZE (mm)
625 x 265 x 380
2.22 CU.FT.
0.06 CBM
10.9 KG / 23.9 LBS

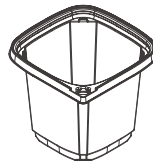

24oz 710ml

PTTESDC24
121 x 121 x 102
500 PCS / CTN.
CTN. SIZE (mm)
625 x 265 x 430
2.51 CU.FT.
0.07 CBM
12.9 KG / 28.4 LBS

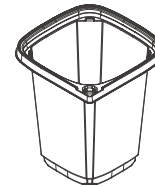

32oz 910ml

PTTESDC32
121 x 121 x 133
500 PCS / CTN.
CTN. SIZE (mm)
625 x 265 x 500
2.92 CU.FT.
0.08 CBM
16.9 KG / 37.4 LBS



**LID
(8-32oz)**

PTTESDCLID
116 x 116 x 7
500 PCS / CTN.
CTN. SIZE (mm)
580 x 250 x 290
1.48 CU.FT.
0.04 CBM
5.0 KG / 11.1 LBS

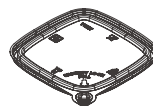

**LID VENTED
(8-32oz)**

PTTESDCLID-V
116 x 116 x 7
500 PCS / CTN.
CTN. SIZE (mm)
580 x 250 x 290
1.48 CU.FT.
0.04 CBM
5.0 KG / 11.1 LBS

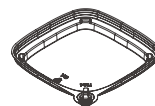

**LID RECESSED
(8-32oz)**

PTTESDCRLID
116 x 116 x 7
500 PCS / CTN.
CTN. SIZE (mm)
580 x 250 x 295
1.51 CU.FT.
0.04 CBM
5.0 KG / 11.1 LBS



**BUT-N-LOC. TAMPER EVIDENT
FLAT PANEL PARFAIT CUPS**

These cups are suitable for cut fruit, cut veggies, cookies, biscuits, yogurt parfaits and other snacks.

Fits into the center console cup holders of most cars. Besides, the flat panel design makes it easy to apply a label and have it lay flat.



9oz 278ml
 RPTTEFPC-09
 111 x 100 x 72
 500 PCS / CTN.
 CTN. SIZE (mm)
 580 x 425 x 385
 3.35 CU.FT.
 0.09 CBM
 11.2 KG / 24.7 LBS



11oz 335ml
 RPTTEFPC-11
 111 x 100 x 88
 500 PCS / CTN.
 CTN. SIZE (mm)
 580 x 425 x 410
 3.57 CU.FT.
 0.10 CBM
 12.9 KG / 28.4 LBS



13oz 400ml
 RPTTEFPC-13
 111 x 100 x 108
 450 PCS / CTN.
 CTN. SIZE (mm)
 580 x 425 x 400
 3.48 CU.FT.
 0.10 CBM
 9.8 KG / 21.6 LBS

VENTED



9oz 278ml
 RPTTEFPC-09V
 111 x 100 x 72
 500 PCS / CTN.
 CTN. SIZE (mm)
 580 x 425 x 385
 3.35 CU.FT.
 0.09 CBM
 11.2 KG / 24.7 LBS

VENTED



11oz 335ml
 RPTTEFPC-11V
 111 x 100 x 88
 500 PCS / CTN.
 CTN. SIZE (mm)
 580 x 425 x 410
 3.57 CU.FT.
 0.10 CBM
 12.9 KG / 28.4 LBS

VENTED



13oz 400ml
 RPTTEFPC-13V
 111 x 100 x 108
 450 PCS / CTN.
 CTN. SIZE (mm)
 580 x 425 x 400
 3.48 CU.FT.
 0.10 CBM
 9.8 KG / 21.6 LBS

INSERT



4oz 120ml
 RPTTEFPC-IN
 94 x 81 x 36
 1,200 PCS / CTN.
 CTN. SIZE (mm)
 501 x 391 x 315
 2.18 CU.FT.
 0.06 CBM
 6.4 KG / 14.0 LBS

INSERT 2C



4oz 110ml
 RPTTEFPC-IN2
 94 x 81 x 36
 1,200 PCS / CTN.
 CTN. SIZE (mm)
 501 x 391 x 315
 2.18 CU.FT.
 0.06 CBM
 7.6 KG / 16.7 LBS



TEAR OFF STRIP

TAMPER EVIDENT
HINGED CONTAINER SERIES



Tear strip locks provide protection to ensure that the container has not been opened since the product was packaged.

Special patented curved design that reduces sharp edges after tearing.



TAMPER EVIDENT TEAR OFF STRIP HINGED CONTAINERS



8oz

T008

147 x 128 x 39
240 PCS / CTN.
CTN. SIZE (mm)
527 x 314 x 329
1.92 CU.FT.
0.05 CBM
4.8 KG / 10.7 LBS



12oz

T012

147 x 128 x 51
240 PCS / CTN.
CTN. SIZE (mm)
527 x 314 x 342
2.00 CU.FT.
0.06 CBM
5.2 KG / 11.5 LBS



16oz

T016

147 x 128 x 65
240 PCS / CTN.
CTN. SIZE (mm)
527 x 314 x 356
2.08 CU.FT.
0.06 CBM
6.2 KG / 13.7 LBS

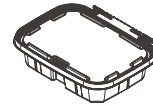

20oz

T020

189 x 145 x 46
200 PCS / CTN.
CTN. SIZE (mm)
380 x 312 x 516
2.16 CU.FT.
0.06 CBM
7.4 KG / 16.2 LBS

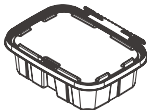

24oz

T024

189 x 143 x 57
200 PCS / CTN.
CTN. SIZE (mm)
380 x 312 x 528
2.21 CU.FT.
0.06 CBM
8.0 KG / 17.7 LBS

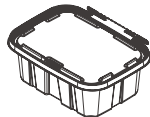

32oz

T032

189 x 146 x 70
200 PCS / CTN.
CTN. SIZE (mm)
380 x 312 x 540
2.26 CU.FT.
0.06 CBM
8.4 KG / 18.6 LBS

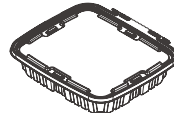

35oz

T035

223 x 201 x 44
180 PCS / CTN.
CTN. SIZE (mm)
455 x 425 x 455
3.11 CU.FT.
0.09 CBM
11.0 KG / 24.2 LBS

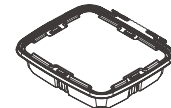

35oz SMOOTH WALL

T035SW

223 x 201 x 44
180 PCS / CTN.
CTN. SIZE (mm)
455 x 425 x 455
3.11 CU.FT.
0.09 CBM
11.0 KG / 24.2 LBS

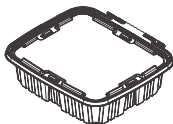

48oz

T048

223 x 201 x 60
176 PCS / CTN.
CTN. SIZE (mm)
455 x 425 x 470
3.21 CU.FT.
0.09 CBM
11.5 KG / 25.3 LBS

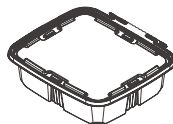

48oz SMOOTH WALL

T048SW

223 x 201 x 60
176 PCS / CTN.
CTN. SIZE (mm)
455 x 425 x 470
3.21 CU.FT.
0.09 CBM
11.5 KG / 25.3 LBS

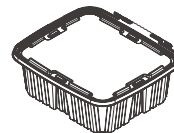

64oz

T064

223 x 201 x 77
164 PCS / CTN.
CTN. SIZE (mm)
475 x 425 x 470
3.35 CU.FT.
0.09 CBM
12.6 KG / 27.8 LBS

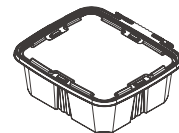

64oz SMOOTH WALL

T064SW

223 x 201 x 77
164 PCS / CTN.
CTN. SIZE (mm)
475 x 425 x 470
3.35 CU.FT.
0.09 CBM
12.6 KG / 27.8 LBS



TAMPER EVIDENT HINGED SQUARE TEAR OFF STRIP CONTAINER



8oz

TOSQ408
128 x 120 x 40
540 PCS / CTN.
CTN. SIZE (mm)
527 x 375 x 563
3.93 CU.FT.
0.11 CBM
11.4 KG / 25.2 LBS



12oz

TOSQ412
128 x 120 x 54
414 PCS / CTN.
CTN. SIZE (mm)
527 x 375 x 460
3.21 CU.FT.
0.09 CBM
10.6 KG / 23.3 LBS



16oz

TOSQ416
128 x 120 x 75
390 PCS / CTN.
CTN. SIZE (mm)
527 x 375 x 470
3.28 CU.FT.
0.09 CBM
13.0 KG / 28.6 LBS



24oz

TOSQ424
128 x 120 x 100
330 PCS / CTN.
CTN. SIZE (mm)
527 x 375 x 463
3.23 CU.FT.
0.09 CBM
14.2 KG / 31.4 LBS



32oz

TOSQ432
128 x 120 x 129
300 PCS / CTN.
CTN. SIZE (mm)
527 x 375 x 438
3.06 CU.FT.
0.09 CBM
14.7 KG / 32.5 LBS



TAMPER EVIDENT HINGED ROUND TEAR OFF STRIP CONTAINER



8oz

TOR408V
135 x 131 x 44
444 PCS / CTN.
CTN. SIZE (mm)
558 x 407 x 576
4.61 CU.FT.
0.13 CBM
12.6 KG / 27.8 LBS



12oz

TOR412V
135 x 131 x 60
420 PCS / CTN.
CTN. SIZE (mm)
558 x 407 x 572
4.58 CU.FT.
0.13 CBM
15.4 KG / 33.9 LBS



16oz

TOR416V
135 x 131 x 76
408 PCS / CTN.
CTN. SIZE (mm)
558 x 407 x 576
4.61 CU.FT.
0.13 CBM
16.8 KG / 37.1 LBS



24oz

TOR424V
135 x 131 x 107
390 PCS / CTN.
CTN. SIZE (mm)
558 x 407 x 574
4.60 CU.FT.
0.13 CBM
16.7 KG / 36.8 LBS



25oz

TOR425P
135 x 131 x 122
402 PCS / CTN.
CTN. SIZE (mm)
558 x 407 x 576
4.61 CU.FT.
0.13 CBM
17.8 KG / 39.2 LBS



32oz

TOR432V
135 x 131 x 148
312PCS / CTN.
CTN. SIZE (mm)
558 x 407 x 556
4.46 CU.FT.
0.13 CBM
16.9 KG / 37.2 LBS



TAMPER EVIDENT HINGED TEAR OFF PARFAIT CUP



8oz
TORPC8
114 x 109 x 61
456 PCS / CTN.
CTN. SIZE (mm)
477 x 343 x 573
3.31 CU.FT.
0.09 CBM
7.0 KG / 15.5 LBS



8oz
TORPC8D
114 x 109 x 89
456 PCS / CTN.
CTN. SIZE (mm)
477 x 343 x 573
3.31 CU.FT.
0.09 CBM
7.0 KG / 15.5 LBS



12oz
TORPC12
114 x 109 x 86
432 PCS / CTN.
CTN. SIZE (mm)
477 x 343 x 573
3.31 CU.FT.
0.09 CBM
8.6 KG / 19.0 LBS



12oz
TORPC12D
114 x 109 x 115
432 PCS / CTN.
CTN. SIZE (mm)
477 x 343 x 573
3.31 CU.FT.
0.09 CBM
8.6 KG / 19.0 LBS



16oz
TORPC16
114 x 109 x 113
408 PCS / CTN.
CTN. SIZE (mm)
477 x 343 x 573
3.31 CU.FT.
0.09 CBM
11. KG / 24.2 LBS



16oz
TORPC16D
114 x 109 x 140
408 PCS / CTN.
CTN. SIZE (mm)
477 x 343 x 573
3.31 CU.FT.
0.09 CBM
11. KG / 24.2 LBS



DESIGNED FOR
VG TAMPER EVIDENT
HINGED LID CONTAINERS

CLOSING MACHINE



IDEAL DESIGN FOR
FRESH PRODUCE
PACKAGING



ACCELERATES
AND SIMPLIFIES
CLOSING PROCESS



COMPACT, EASY TO USE,
CLEAN AND MAINTAIN

VPA200-1

1975 x 998 x 1055 (mm)

77.8 x 39.3 x 41.5 (in)

150kg (330.7 lbs)

CTN. SIZE (mm) 2180 x 1200 x 1390
CTN. G.W. 250 KG / 551.2 LBS

VG automatic closing machine is designed specifically for our patented **BUT-N-LOC** tamper evident hinged lid containers, operates with sizes 8oz to 64oz, and processes up to 80 containers per minute. Sturdy aluminum and steel construction with electronic control system for flexible ease of use operation.

Our machine increases productivity through reduced labour costs, improved reliability and output. Ideal secure packaging system for a wide variety of fresh food products, VG automatic closing machines are as efficient as they are effective.



PET HINGED TYPE DELI CONTAINER

These containers can be made from post-consumer recycled PET (rPET) according to customer needs, provide environmental benefits and meet customer demand for more sustainable food packaging. Our products has been assessed and found conforming to the requirements of U.S.F.D.A. and offer enhanced clarity for superior product visibility, one-piece hinged construction and spill-resistant closures.

Available in 15 most popular sizes from 4 to 64 oz., suitable for main and side dishes and bulk foods, they are the perfect choice for all your deli packaging needs - cold pasta, fruit or potato salad, leafy green salads, sandwiches, dried fruit and nuts, bulk candy, desserts and more. Ideal for supermarkets, delis, wholesale clubs, c-stores.



4oz

RPTHLD4
107 x 95 x 34
400 PCS / CTN.
CTN. SIZE (mm)
550 x 410 x 240
1.91 CU.FT.
0.05 CBM
5.4 KG / 11.9 LBS



6oz

RPTHLD6
107 x 95 x 48
400 PCS / CTN.
CTN. SIZE (mm)
565 x 410 x 240
1.96 CU.FT.
0.06 CBM
6.1 KG / 13.4 LBS



8oz

RPTHLD8
142 x 125 x 35
200 PCS / CTN.
CTN. SIZE (mm)
440 x 265 x 315
1.30 CU.FT.
0.04 CBM
3.9 KG / 8.7 LBS

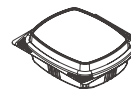

8oz TALL

RPTHLD8T
142 x 125 x 45
200 PCS / CTN.
CTN. SIZE (mm)
480 x 265 x 315
1.41 CU.FT.
0.04 CBM
4.3 KG / 9.6 LBS

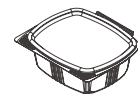

12oz

RPTHLD12
142 x 125 x 49
200 PCS / CTN.
CTN. SIZE (mm)
450 x 265 x 315
1.33 CU.FT.
0.04 CBM
4.1 KG / 9.0 LBS

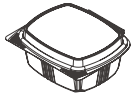

12oz TALL

RPTHLD12T
142 x 125 x 59
200 PCS / CTN.
CTN. SIZE (mm)
490 x 265 x 315
1.44 CU.FT.
0.04 CBM
4.3 KG / 9.6 LBS

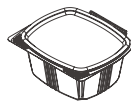

16oz

RPTHLD16
142 x 125 x 63
200 PCS / CTN.
CTN. SIZE (mm)
510 x 265 x 315
1.50 CU.FT.
0.04 CBM
4.7 KG / 10.3 LBS

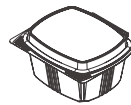

16oz TALL

RPTHLD16T
142 x 125 x 72
200 PCS / CTN.
CTN. SIZE (mm)
510 x 265 x 315
1.50 CU.FT.
0.04 CBM
5.0 KG / 11.1 LBS

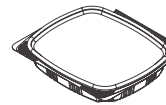

16oz SHALLOW

RPTHLD16S
183 x 161 x 33
200 PCS / CTN.
CTN. SIZE (mm)
425 x 350 x 390
2.05 CU.FT.
0.06 CBM
7.2 KG / 15.9 LBS

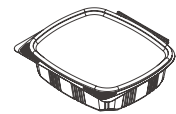

24oz

RPTHLD24
183 x 161 x 47
200 PCS / CTN.
CTN. SIZE (mm)
480 x 350 x 390
2.31 CU.FT.
0.07 CBM
7.9 KG / 17.3 LBS

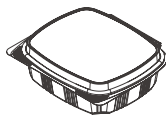

24oz TALL

RPTHLD24T
183 x 161 x 57
200 PCS / CTN.
CTN. SIZE (mm)
520 x 350 x 390
2.51 CU.FT.
0.07 CBM
8.6 KG / 18.9 LBS

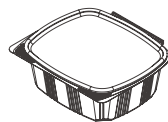

32oz

RPTHLD32
183 x 161 x 65
200 PCS / CTN.
CTN. SIZE (mm)
510 x 350 x 390
2.46 CU.FT.
0.07 CBM
8.6 KG / 18.9 LBS

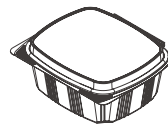

32oz TALL

RPTHLD32T
183 x 161 x 75
200 PCS / CTN.
CTN. SIZE (mm)
510 x 350 x 390
2.46 CU.FT.
0.07 CBM
8.4 KG / 18.4 LBS

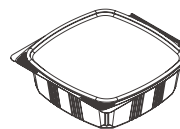

48oz

RPTHLD48
203 x 202 x 63
200 PCS / CTN.
CTN. SIZE (mm)
490 x 430 x 430
3.20 CU.FT.
0.09 CBM
11.4 KG / 25.1 LBS

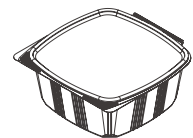

64oz

RPTHLD64
203 x 202 x 84
200 PCS / CTN.
CTN. SIZE (mm)
560 x 430 x 430
3.66 CU.FT.
0.10 CBM
13.0 KG / 28.6 LBS



PET HINGED TYPE BAKERY CONTAINERS

It's resealable and reliable for delis, concession stands, food trucks, cafes, and any food service establishment that offers take-out.

Crystal clear design provides optimal product visibility, making your food instantly identifiable. Display a variety of popular snack foods such as muffins, cupcakes, or cookies, the possibilities are endless!

label window provides an ideal location for a label or tamper evident seal.

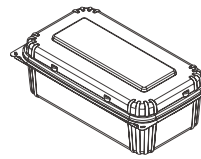

BHC35
 228 x 133 x 82
 100 PCS / CTN.
 CTN. SIZE (mm)
 471 x 288 x 376
 1.80 CU.FT.
 0.05 CBM
 4.5 KG / 9.9 LBS

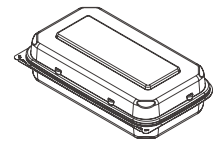

BHC35-225
 228 x 133 x 63
 280 PCS / CTN.
 CTN. SIZE (mm)
 580 x 480 x 462
 4.54 CUFT
 0.13 CBM
 10.6 KG / 23.9 LBS

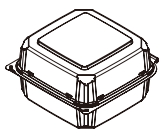

PTH66
 144 x 141 x 79
 356 PCS / CTN.
 CTN. SIZE (mm)
 582 x 341 x 312
 2.19 CU.FT.
 0.06 CBM
 7.9 KG / 17.4 LBS

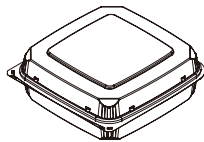

PTH88
 207 x 204 x 70
 300 PCS / CTN.
 CTN. SIZE (mm)
 603 x 430 x 428
 3.92 CU.FT.
 0.11 CBM
 14.2 KG / 31.2 LBS

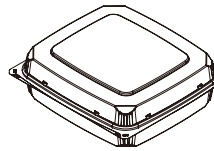

PTH98
 231 x 211 x 70
 164 PCS / CTN.
 CTN. SIZE (mm)
 477 x 340 x 448
 2.57 CU.FT.
 0.07 CBM
 9.8 KG / 21.7 LBS

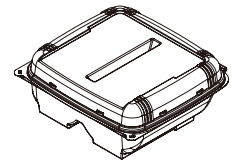

PTHSJC
 231 x 213 x 89
 100 PCS / CTN.
 CTN. SIZE (mm)
 580 x 438 x 256
 2.30 CU.FT.
 0.07 CBM
 6.3 KG / 13.9 LBS

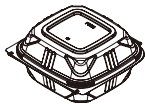

PV756
 159 x 154 x 79
 330 PCS / CTN.
 CTN. SIZE (mm)
 540 x 340 x 510
 3.31 CU.FT.
 0.09 CBM
 8.4 KG / 18.6 LBS

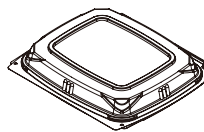

PV727
 228 x 199 x 51
 110 PCS / CTN.
 CTN. SIZE (mm)
 559 x 415 x 252
 2.06 CU.FT.
 0.06 CBM
 5.3 KG / 11.7 LBS

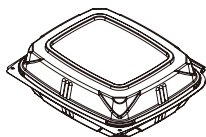

PV747
 228 x 198 x 72
 110 PCS / CTN.
 CTN. SIZE (mm)
 570 x 415 x 252
 2.10 CU.FT.
 0.06 CBM
 6.1 KG / 13.4 LBS

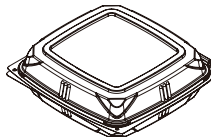

PV785
 237 x 233 x 74
 100 PCS / CTN.
 CTN. SIZE (mm)
 480 x 450 x 270
 2.06 CU.FT.
 0.06 CBM
 6.9 KG / 15.3 LBS

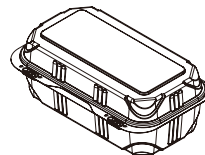

PV735
 229 x 114 x 84
 250 PCS / CTN.
 CTN. SIZE (mm)
 581 x 310 x 485
 3.08 CU.FT.
 0.09 CBM
 11.7 KG / 25.9 LBS



HINGED TYPE BUTTER LETTUCE CONTAINERS

This container offers both superb clarity and protection on the go, and helps maintain lettuce freshness.

Well suited for food processors & packers, wholesale clubs, and supermarkets.

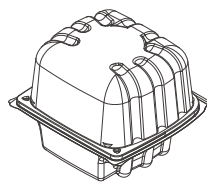

PTHBLC-1
 185 x 167 x 144
 270 PCS / CTN.
 CTN. SIZE (mm)
 605 x 399 x 353
 3.01 CU.FT.
 0.09 CBM
 11.8 KG / 26.1 LBS

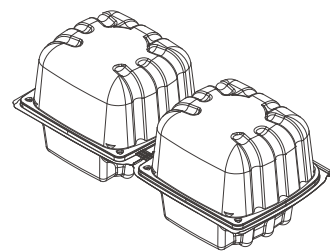

PTHBLC-2
 380 x 164 x 144
 135 PCS / CTN.
 CTN. SIZE (mm)
 605 x 399 x 353
 3.01 CU.FT.
 0.09 CBM
 11.8 KG / 26.1 LBS



SINGLE / DOUBLE CLAMSHELL



This container is ideal for herb with root ball attached.

The clarity and air proof function offer the contents visibility and freshness maintenance.

It's perfect for supermarket display and space-saving storage.

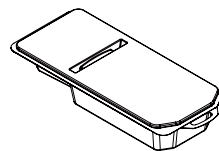

SINGLE CLAMSHELL

PTHSLHCL-NSL
 231 x 75 x 37
 318 PCS / CTN.
 CTN. SIZE (mm)
 631 x 505 x 256
 2.88 CU.FT.
 0.08 CBM
 9.43 KG / 20.8 LBS

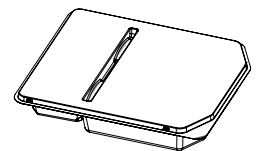

DOUBLE CLAMSHELL

PTHDLHCL-NSL
 199 x 186 x 38
 200 PCS / CTN.
 CTN. SIZE (mm)
 454 x 387 x 455
 2.82 CU.FT.
 0.08 CBM
 10.70 KG / 23.6 LBS



PET CLEAR 4 COMP. SNACK CONTAINER

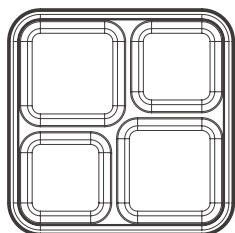

6" x 6" in

This 6"x6"4 compartment square snack container is ideal for separating equal quantities of food, ideal for patron's picnics, lunches, or on-the-go snacks. This container let you create variety of meal and snack combos and showcase them.

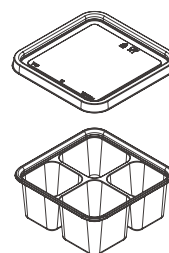

PTSNAK4
153 x 153 x 63
300 SETS / CTN.
CTN. SIZE (mm)
700 x 490 x 340
4.12 CU.FT.
0.12 CBM
13.2 KG / 29.0 LBS



PET CLEAR ROUND DELI CONTAINERS

VG PET clear round deli containers are perfect for high quality in store presentation and packaging a wide variety of fresh and precooked food, salads, fruit, sauces, nuts, confectionery and more. Leak resistant for safe & convenient transportation.

The crystal clear appearance allows you to set up eye-catching food displays that look more flavorful and delicious, and stimulate impulse purchases.

One common size snap-fit lid helps maintain freshness. Product is stackable for maximum shelf space utilization. Well suited for supermarkets, food processors & packers, wholesale clubs, and C-stores.



4.61"
117mm Dia.

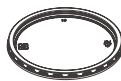

RECESSED LID
PTRDCLIDIN
122 x 8
500 PCS / CTN.
CTN. SIZE (mm)
630 x 250 x 240
1.33 CU.FT.
0.04 CBM
3.2 KG / 7.1 LBS



OVERCAP LID
PTRDCLIDOUT
120 x 13
500 PCS / CTN.
CTN. SIZE (mm)
630 x 250 x 240
1.33 CU.FT.
0.04 CBM
3.1 KG / 6.9 LBS



DOME LID
PTRDCDOME
120 x 45
500 PCS / CTN.
CTN. SIZE (mm)
630 x 250 x 225
1.25 CU.FT.
0.04 CBM
4.3 KG / 9.4 LBS



8oz
PTRDC08
117 x 97 x 41
500 PCS / CTN.
CTN. SIZE (mm)
600 x 250 x 340
1.80 CU.FT.
0.05 CBM
5.2 KG / 11.4 LBS



12oz
PTRDC12
117 x 94 x 60
500 PCS / CTN.
CTN. SIZE (mm)
600 x 250 x 345
1.83 CU.FT.
0.05 CBM
6.2 KG / 13.7 LBS



16oz
PTRDC16
117 x 91 x 75
500 PCS / CTN.
CTN. SIZE (mm)
600 x 250 x 365
1.93 CU.FT.
0.05 CBM
8.7 KG / 19.3 LBS



24oz
PTRDC24
117 x 86 x 110
500 PCS / CTN.
CTN. SIZE (mm)
600 x 250 x 410
2.17 CU.FT.
0.06 CBM
10.3 KG / 22.6 LBS



32oz
PTRDC32
117 x 82 x 142
500 PCS / CTN.
CTN. SIZE (mm)
600 x 250 x 490
2.59 CU.FT.
0.07 CBM
11.4 KG / 25.1 LBS



PET CLEAR 32oz ROUND PRODUCE CONTAINER



32oz (172mm)

PTRRC32-D172
 172 x 120 x 75
 500 PCS / CTN.
 CTN. SIZE (mm)
 375 x 375 x 630
 3.13 CU.FT.
 0.09 CBM
 17.0 KG / 37.5 LBS



OVERCAP LID

PTRRCLID-D172
 176 x 8
 500 PCS / CTN.
 CTN. SIZE (mm)
 375 x 375 x 590
 2.93 CU.FT.
 0.08 CBM
 6.0 KG / 13.2 LBS

It's just the right size for single serving salads, fruits, cut veggies, pastas and side items. It's designed for transporting and storing cold food items. Tight lid fit prevents spills – in the store and on the go – and helps maintain product freshness.

You'll have no trouble selling produce, jujube, berries, and even herbs! Ideas for supermarkets, delis, wholesale clubs, and C-stores.



PET CLEAR SALAD BOWLS

These fresh view bowls are specifically designed to showcase your bakery, deli, produce and “grab-and-go” items. Made of durable, crack-resistant and clear PET, these bowls are the perfect complement for pre-packed or fresh salads and cut fruit. The no-spill lid is also perfect for stacking. Available in bulk or combo pack, and with clear or black bases.



175mm Dia.



18oz

PTSB18-D175
175 x 50 x 20

150 SETS / CTN.
CTN. SIZE (mm)
543 x 188 x 565
2.04 CU.FT. / 0.06 CBM
4.1 KG / 9.1 LBS

300 SETS / CTN.
CTN. SIZE (mm)
575 x 533 x 376
4.07 CU.FT. / 0.12 CBM
8.2 KG / 18.0 LBS

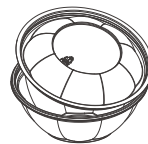

24oz

PTSB24-D175
175 x 62 x 20

150 SETS / CTN.
CTN. SIZE (mm)
543 x 188 x 583
2.10 CU.FT. / 0.06 CBM
4.7 KG / 10.3 LBS

300 SETS / CTN.
CTN. SIZE (mm)
603 x 533 x 376
4.27 CU.FT. / 0.12 CBM
9.5 KG / 20.9 LBS

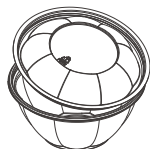

32oz

PTSB32-D175
175 x 83 x 20

150 SETS / CTN.
CTN. SIZE (mm)
543 x 188 x 600
2.16 CU.FT. / 0.06 CBM
5.4 KG / 12.0 LBS

300 SETS / CTN.
CTN. SIZE (mm)
630 x 533 x 376
4.46 CU.FT. / 0.13 CBM
11.1 KG / 24.4 LBS

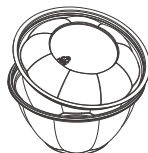

48oz

PTSB48-D175
175 x 112 x 20

150 SETS / CTN.
CTN. SIZE (mm)
543 x 188 x 620
2.23 CU.FT. / 0.06 CBM
6.9 KG / 15.2 LBS

300 SETS / CTN.
CTN. SIZE (mm)
650 x 533 x 376
4.60 CU.FT. / 0.13 CBM
13.6 KG / 30.0 LBS

225mm Dia.

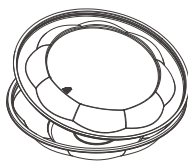

40oz

PTSB40-D255
225 x 50 x 25

100 SETS / CTN.
CTN. SIZE (mm)
520 x 276 x 390
1.98 CU.FT. / 0.06 CBM
6.1 KG / 13.3 LBS

200 SETS / CTN.
CTN. SIZE (mm)
521 x 500 x 542
4.98 CU.FT. / 0.14 CBM
12.4 KG / 27.3 LBS

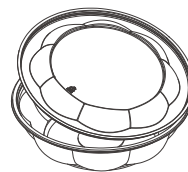

64oz

TSB64-D255
225 x 73 x 25

100 SETS / CTN.
CTN. SIZE (mm)
520 x 276 x 445
2.25 CU.FT. / 0.06 CBM
6.8 KG / 15.1 LBS

200 SETS / CTN.
CTN. SIZE (mm)
535 x 510 x 542
5.22 CU.FT. / 0.15 CBM
13.9 KG / 30.6 LBS



PET CAKE & PIE CONTAINERS



VG Cake & Bakery Container with clear dome lids are great for selling and merchandising your 6-10" cakes or pies!

The base is made of durable black PET, and an included clear dome lid allows for optimum viewing of every decorated side as well as protecting your sweets during transport.

Easy to label lid side



FEATURES AND BENEFITS

- Ideal for supermarkets, bakeries and wholesale clubs.
- Suitable for cakes, pies, and desserts.
- Full view of the product at all times.
- PET lid offers both superb clarity and protection against damage.
- Packaging boasts a solid dome lid to base lock.

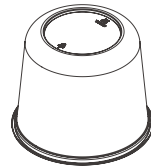

6"

PTCC6

196 x 205 x 168.5

100 SETS / CTN.

CTN. SIZE (mm)

800 x 410 x 225

2.61 CU.FT. / 0.07 CBM

8.5 KG / 18.8 LBS

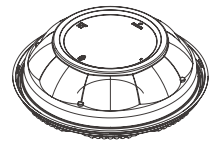

9" PIE

PTPC9SL

153 x 258 x 100

110 SETS / CTN.

CTN. SIZE (mm)

640 x 530 x 270

3.23 CU.FT. / 0.09 CBM

9.2 KG / 20.3 LBS



8" SINGLE

NFPTCC8SL

259 x 265 x 102.8

100 SETS / CTN.

CTN. SIZE (mm)

620 x 530 x 285

3.31 CU.FT. / 0.09 CBM

10.5 KG / 23.2 LBS

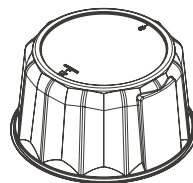

8" DOUBLE

NFPTCC8DL

259 x 265 x 149

100 SETS / CTN.

CTN. SIZE (mm)

620 x 530 x 285

3.31 CU.FT. / 0.09 CBM

10.9 KG / 24.1 LBS

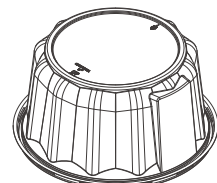

10"

PTCC10DL

259 x 284 x 151

50 SETS / CTN.

CTN. SIZE (mm)

560 x 445 x 305

2.68 CU.FT. / 0.08 CBM

6.9 KG / 15.2 LBS



PET CLEAR CUPS & LIDS

4 DIAMETER RIM SIZES

The glass-like clarity of clear cups allows the appeal of your food and drink to shine through. Whether for iced beverages, smoothies, frozen drinks, on-the-go snacks or parfaits, they give your product that high-end look and feel. Made of crack-resistant PET, these cups have outstanding strength and durability.

They are not susceptible to flavor or odor transfer and have smooth rolled rims for safe and comfortable drinking. You can also create new food combinations with our cup inserts.



FEATURES & BENEFITS

- Four rim diameter sizes: 78, 92, 98, and 107mm. 4oz cup inserts to fits 92mm & 98mm rim cups.
- Large and flat area for customer branding. Printing up to 6-colors.
- Excellent for coffee shops, restaurants, supermarkets, C-stores and sports venues.



Available in PET, Blended PET, or RPET



9oz

PTC09SW-D92
92 x 55 x 72
1,000 PCS / CTN.
CTN. SIZE (mm)
476 x 386 x 348
2.26 CU.FT.
0.06 CBM
10.1 KG / 22.2 LBS



12oz TALL

PTC12-D92
92 x 60 x 106
1,000 PCS / CTN.
CTN. SIZE (mm)
476 x 386 x 435
2.82 CU.FT.
0.08 CBM
12.5 KG / 27.6 LBS



16oz

PTC16-D92
92 x 61 x 124
1,000 PCS / CTN.
CTN. SIZE (mm)
476 x 386 x 545
3.53 CU.FT.
0.10 CBM
14.2 KG / 31.4 LBS



20oz

PTC20-D92
92 x 65 x 148
1,000 PCS / CTN.
CTN. SIZE (mm)
476 x 386 x 430
2.79 CU.FT.
0.08 CBM
17.7 KG / 39.0 LBS



9oz

PTC09-D92
92 x 55 x 73
1,000 PCS / CTN.
CTN. SIZE (mm)
476 x 386 x 348
2.26 CU.FT.
0.06 CBM
10.1 KG / 22.2 LBS



425ml

PTC425-D92
92 x 56 x 118
1,000 PCS / CTN.
CTN. SIZE (mm)
476 x 386 x 425
2.76 CU.FT.
0.08 CBM
12.5 KG / 27.5 LBS



4oz INSERT

PTINS-D92
92 x 67 x 26
1,000 PCS / CTN.
CTN. SIZE (mm)
490 x 214 x 255
0.94 CU.FT.
0.03 CBM
3.5 KG / 7.7 LBS



NO SLOT

PTLID-F92NS
92 x 9
1,000 PCS / CTN.
CTN. SIZE (mm)
485 x 395 x 210
1.42 CU.FT.
0.04 CBM
3.1 KG / 6.8 LBS



STRAW SLOT

PTLID-F92SS
92 x 9
1,000 PCS / CTN.
CTN. SIZE (mm)
485 x 395 x 210
1.42 CU.FT.
0.04 CBM
3.1 KG / 6.8 LBS



NO HOLE with TAB

PTLID-F92NS-T
92 x 11
1,000 PCS / CTN.
CTN. SIZE (mm)
500 x 407 x 262
1.88 CU.FT.
0.05 CBM
3.8 KG / 8.3 LBS



STRAW SLOT

PTLID-D92SS
92 x 45
1,000 PCS / CTN.
CTN. SIZE (mm)
495 x 425 x 210
1.56 CU.FT.
0.04 CBM
4.3 KG / 9.5 LBS



ROUND HOLE

PTLID-D92RH
92 x 45
1,000 PCS / CTN.
CTN. SIZE (mm)
495 x 425 x 210
1.56 CU.FT.
0.04 CBM
4.3 KG / 9.5 LBS



WIDE HOLE

PTLID-D92WH
92 x 38
1,000 PCS / CTN.
CTN. SIZE (mm)
495 x 460 x 210
1.69 CU.FT.
0.05 CBM
4.5 KG / 9.9 LBS



NO HOLE

PTLID-D92NH
92 x 45
1,000 PCS / CTN.
CTN. SIZE (mm)
495 x 425 x 210
1.56 CU.FT.
0.04 CBM
4.3 KG / 9.5 LBS

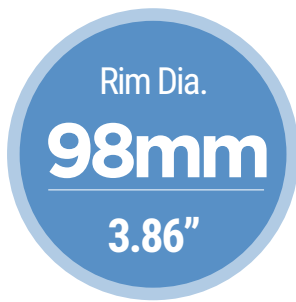

Available in PET, Blended PET, or RPET



12/14oz
 PTC14-D98
 98 x 55 x 103
 1,000 PCS / CTN.
 CTN. SIZE (mm)
 506 x 403 x 375
 2.70 CU.FT.
 0.08 CBM
 13.4 KG / 29.5 LBS



16/18oz
 PTC16-D98
 98 x 63 x 118
 1,000 PCS / CTN.
 CTN. SIZE (mm)
 506 x 403 x 380
 2.74 CU.FT.
 0.08 CBM
 15.7 KG / 34.6 LBS



20oz
 PTC20-D98
 98 x 59 x 137
 1,000 PCS / CTN.
 CTN. SIZE (mm)
 506 x 403 x 420
 3.02 CU.FT.
 0.09 CBM
 17.4 KG / 38.4 LBS



24oz
 PTC24-D98
 98 x 62 x 151
 600 PCS / CTN.
 CTN. SIZE (mm)
 400 x 300 x 480
 2.03 CU.FT.
 0.06 CBM
 11.2 KG / 24.7 LBS



5oz INSERT
 PTINS-D98
 98 x 74 x 30
 1,000 PCS / CTN.
 CTN. SIZE (mm)
 510 x 215 x 325
 1.26 CU.FT.
 0.04 CBM
 4.3 KG / 9.4 LBS



NO SLOT
 PTLID-F98NS
 98 x 10
 1,000 PCS / CTN.
 CTN. SIZE (mm)
 532 x 432 x 212
 1.72 CU.FT.
 0.05 CBM
 4.0 KG / 8.9 LBS



STRAW SLOT
 PTLID-F98SS
 98 x 10
 1,000 PCS / CTN.
 CTN. SIZE (mm)
 532 x 432 x 212
 1.72 CU.FT.
 0.05 CBM
 4.0 KG / 8.9 LBS



STRAWLESS SIP LID
 PTLID-S98
 98 x 23
 1,000 PCS / CTN.
 CTN. SIZE (mm)
 530 x 426 x 235
 1.87 CU.FT.
 0.05 CBM
 4.4 KG / 9.6 LBS



STRAW SLOT
 PTLID-D98SS
 98 x 46
 1,000 PCS / CTN.
 CTN. SIZE (mm)
 525 x 445 x 225
 1.86 CU.FT.
 0.05 CBM
 5.3 KG / 11.7 LBS



ROUND HOLE
 PTLID-D98RH
 98 x 46
 1,000 PCS / CTN.
 CTN. SIZE (mm)
 525 x 445 x 225
 1.86 CU.FT.
 0.05 CBM
 5.3 KG / 11.7 LBS



NO HOLE
 PTLID-D98NH
 98 x 46
 1,000 PCS / CTN.
 CTN. SIZE (mm)
 525 x 445 x 225
 1.86 CU.FT.
 0.05 CBM
 5.3 KG / 11.7 LBS



WIDE HOLE
 PTLID-D98WH
 98 x 40
 1,000 PCS / CTN.
 CTN. SIZE (mm)
 525 x 445 x 225
 1.86 CU.FT.
 0.05 CBM
 5.3 KG / 11.7 LBS



Available in PET, Blended PET, or RPET



7oz

PTC07-D78
78 x 48 x 81
1,000 PCS / CTN.
CTN. SIZE (mm)
400 x 320 x 330
1.49 CU.FT.
0.04 CBM
8.0 KG / 17.5 LBS



8oz

PTC08-D78
78 x 53 x 81
1,000 PCS / CTN.
CTN. SIZE (mm)
400 x 320 x 420
1.90 CU.FT.
0.05 CBM
7.3 KG / 16.2 LBS



10oz

PTC10-D78
78 x 51 x 103
1,000 PCS / CTN.
CTN. SIZE (mm)
400 x 320 x 440
1.99 CU.FT.
0.06 CBM
8.1 KG / 17.8 LBS



STRAW SLOT

PTLID-F78SS
78 x 7
2,000 PCS / CTN.
CTN. SIZE (mm)
415 x 345 x 340
1.72 CU.FT.
0.05 CBM
4.0 KG / 8.8 LBS



STRAW SLOT

PTLID-D78RH
78 x 37
2,000 PCS / CTN.
CTN. SIZE (mm)
440 x 410 x 330
2.10 CU.FT.
0.06 CBM
5.4 KG / 11.9 LBS



STRAW SLOT

PTLID-F107SS
107 x 11
500 PCS / CTN.
CTN. SIZE (mm)
560 x 240 x 240
1.14 CU.FT.
0.03 CBM
2.2 KG / 4.8 LBS



STRAW SLOT

PTLID-D107SS
107 x 43
500 PCS / CTN.
CTN. SIZE (mm)
590 x 240 x 300
1.50 CU.FT.
0.04 CBM
3.1 KG / 6.9 LBS



ROUND HOLE

PTLID-D107RH
107 x 43
500 PCS / CTN.
CTN. SIZE (mm)
590 x 240 x 300
1.50 CU.FT.
0.04 CBM
3.1 KG / 6.9 LBS



32oz

PTC32-D107
107 x 73 x 175
500 PCS / CTN.
CTN. SIZE (mm)
565 x 455 x 430
3.90 CU.FT.
0.11 CBM
14.9 KG / 32.8 LBS



PLA BIOPLASTIC CLEAR CUPS & SALAD BOWL



PLA COMPOSTABLE BIOPLASTICS MADE FROM PLANT STARCHES

WHAT IS PLA?



PLA (PolyLactic Acid) is made from plants not oil, derived from natural sources like corn starch, cassava, or sugar cane.

HOW PLA IS MADE?

- 01 Harvesting the corn, extract the starch in the form of glucose.
- 02 Fermentation process turning glucose into lactic acid.
- 03 Turning lactic acid into a polymer, which can be made into PLA resin.



NatureWorks is the world's largest producer of PLA, our PLA clear cups made from 100% NatureWorks Ingeo™ resin produced in the USA.

100% BIODEGRADABLE



PLA products will completely biodegrade within 120 days in a commercial compost facility. Return nutrients back into soil.

LOW CARBON FOOTPRINT



The production of Ingeo® bioplastic emits 75% less greenhouse gas emissions compared to PET.



STORE IN THE COOL PLACE.
IDEAL BEVERAGE TEMPERATURE WITHIN 40°C / 104°F



9oz SQUAT
PLAC09SW-D92
92 x 61 x 72
1,000 PCS / CTN.
CTN. SIZE (mm)
476 x 386 x 350
2.27 CU.FT.
0.06 CBM
10.1 KG / 22.2 LBS



12oz Tall
PLAC12-D92
92 x 59 x 106
1,000 PCS / CTN.
CTN. SIZE (mm)
476 x 386 x 375
2.43 CU.FT.
0.07 CBM
11.3 KG / 25.0 LBS



16oz
PLAC16-D92
92 x 61 x 125
1,000 PCS / CTN.
CTN. SIZE (mm)
480 x 390 x 375
2.48 CU.FT.
0.07 CBM
13.7 KG / 30.3 LBS

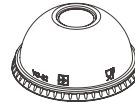

ROUND HOLE
PLALID-D92RH
92 x 45
1,000 PCS / CTN.
CTN. SIZE (mm)
495 x 460 x 210
1.69 CU.FT.
0.05 CBM
4.1 KG / 9.1 LBS



STRAW SLOT
PLALID-F92SS
92 x 9
1,000 PCS / CTN.
CTN. SIZE (mm)
485 x 395 x 220
1.49 CU.FT.
0.04 CBM
3.1 KG / 6.8 LBS



9oz SQUAT
PLAC09SW-D96
96 x 55 x 79
1,000 PCS / CTN.
CTN. SIZE (mm)
504 x 404 x 350
2.52 CU.FT.
0.07 CBM
8.8 KG / 19.5 LBS



12/14oz
PLAC12-D96
96 x 54 x 106
1,000 PCS / CTN.
CTN. SIZE (mm)
504 x 404 x 385
2.77 CU.FT.
0.08 CBM
11.7 KG / 25.8 LBS



16/18oz
PLAC16-D96
96 x 61 x 124
1,000 PCS / CTN.
CTN. SIZE (mm)
504 x 404 x 550
3.95 CU.FT.
0.11 CBM
14.0 KG / 30.8 LBS



20oz
PLAC20-D96
96 x 61 x 141
1,000 PCS / CTN.
CTN. SIZE (mm)
504 x 404 x 610
4.38 CU.FT.
0.12 CBM
15.1 KG / 33.2 LBS



24oz
PLAC24-D96
96 x 64 x 152
1,000 PCS / CTN.
CTN. SIZE (mm)
504 x 404 x 650
4.67 CU.FT.
0.13 CBM
15.6 KG / 34.4 LBS

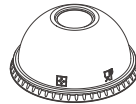

ROUND HOLE
PLALID-D96RH
96 x 45
1,000 PCS / CTN.
CTN. SIZE (mm)
516 x 416 x 265
2.01 CU.FT.
0.06 CBM
4.7 KG / 10.3 LBS



STRAW SLOT
PLALID-F96SS
96 x 9
1,000 PCS / CTN.
CTN. SIZE (mm)
514 x 432 x 214
1.68 CU.FT.
0.05 CBM
3.7 KG / 8.3 LBS



STORE IN THE COOL PLACE.
IDEAL BEVERAGE TEMPERATURE WITHIN 40°C / 104°F



12/14oz
PLAC14-D98
98 x 56 x 103
1,000 PCS / CTN.
CTN. SIZE (mm)
506 x 403 x 375
2.70 CU.FT.
0.08 CBM
13.0 KG / 28.6 LBS



16/18oz
PLAC16-D98
98 x 63 x 118
1,000 PCS / CTN.
CTN. SIZE (mm)
508 x 405 x 370
2.69 CU.FT.
0.08 CBM
13.9 KG / 30.6 LBS



20oz
PLAC20-D98
98 x 60 x 137
1,000 PCS / CTN.
CTN. SIZE (mm)
506 x 403 x 420
3.02 CU.FT.
0.09 CBM
16.1 KG / 35.6 LBS



24oz
PLAC24-D98
98 x 62 x 150
600 PCS / CTN.
CTN. SIZE (mm)
400 x 300 x 480
2.03 CU.FT.
0.06 CBM
10.1 KG / 22.3 LBS

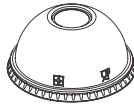

ROUND HOLE
PLALID-D98RH
98 x 46
1,000 PCS / CTN.
CTN. SIZE (mm)
525 x 490 x 230
2.09 CU.FT.
0.06 CBM
4.9 KG / 10.8 LBS



STRAW SLOT
PLALID-F98SS
98 x 10
1,000 PCS / CTN.
CTN. SIZE (mm)
532 x 432 x 232
1.88 CU.FT.
0.05 CBM
3.8 KG / 8.3 LBS



SIP LID
PLALID-S98
98 x 23
1,000 PCS / CTN.
CTN. SIZE (mm)
530 x 426 x 235
1.87 CU.FT.
0.05 CBM
4.4 KG / 9.6 LBS



32oz
PLAC32-D107
108 x 75 x 174
500 PCS / CTN.
CTN. SIZE (mm)
565 x 455 x 430
3.90 CU.FT.
0.11 CBM
14.1 KG / 31.1 LBS



STRAW SLOT
PLALID-F107SS
107 x 11
500 PCS / CTN.
CTN. SIZE (mm)
560 x 240 x 240
1.14 CU.FT.
0.03 CBM
2.3 KG / 5.1 LBS



These fresh view bowls are specifically designed to showcase your bakery, deli, produce and “grab-and-go” items.

These bowls are the perfect complement for pre-packed or fresh salads and cut fruit.

The no-spill lid is also perfect for stacking. Available in bulk or combo pack.

175mm Dia.



18oz
PLASB18-D175
175 x 50 x 20

150 SETS / CTN.
CTN. SIZE (mm)
543 x 188 x 565
2.04 CU.FT. / 0.06 CBM

300 SETS / CTN.
CTN. SIZE (mm)
575 x 533 x 376
4.07 CU.FT. / 0.12 CBM

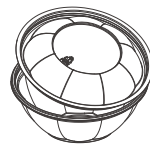

24oz
PLASB24-D175
175 x 62 x 20

150 SETS / CTN.
CTN. SIZE (mm)
543 x 188 x 583
2.10 CU.FT. / 0.06 CBM

300 SETS / CTN.
CTN. SIZE (mm)
603 x 533 x 376
4.27 CU.FT. / 0.12 CBM

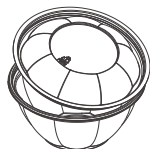

32oz
PLASB32-D175
175 x 83 x 20

150 SETS / CTN.
CTN. SIZE (mm)
543 x 188 x 600
2.16 CU.FT. / 0.06 CBM

300 SETS / CTN.
CTN. SIZE (mm)
630 x 533 x 376
4.46 CU.FT. / 0.13 CBM

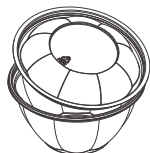

48oz
PLASB48-D175
175 x 112 x 20

150 SETS / CTN.
CTN. SIZE (mm)
543 x 188 x 620
2.23 CU.FT. / 0.06 CBM

300 SETS / CTN.
CTN. SIZE (mm)
650 x 533 x 376
4.60 CU.FT. / 0.13 CBM

225mm Dia.

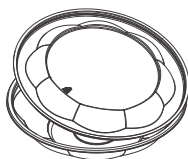

40oz
PLASB40-D255
225 x 50 x 25

100 SETS / CTN.
CTN. SIZE (mm)
520 x 276 x 390
1.98 CU.FT. / 0.06 CBM

200 SETS / CTN.
CTN. SIZE (mm)
521 x 500 x 542
4.98 CU.FT. / 0.14 CBM

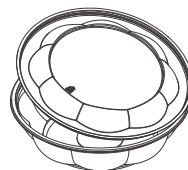

64oz
PLASB64-D255
225 x 73 x 25

100 SETS / CTN.
CTN. SIZE (mm)
520 x 276 x 445
2.25 CU.FT. / 0.06 CBM

200 SETS / CTN.
CTN. SIZE (mm)
535 x 510 x 542
5.22 CU.FT. / 0.15 CBM



HEAVY DUTY MICROWAVE PP CONTAINERS

HEAT + COLD RESISTANCE

- 1** The dome style raised lids that increase the usable space.
- 2** Secure fit to eliminate spills. Audible click closure indicates a secure lock.
- 3** Allow steam to escape which is especially important to prevent food from getting soggy or mushy.
- 4** Recyclable black PP base with clear see-thru lid.



Heat tolerance up to 230° F / 110° C in the microwave oven or display case.

ROUND TYPE COMBO PACK

	16oz ITEM NO. 8311 SIZE: Ø 6 x 2 in.	w/ PP LID COMPO 150 SETS / CTN. CTN. SIZE 473 x 158 x 515mm 1.36 CU.FT. / 0.04 CBM 6.0 KG / 13.23 LBS	w/ OPS LID COMPO 150 SETS / CTN. CTN. SIZE 473 x 158 x 470mm 1.24 CU.FT. / 0.04 CBM 4.7 KG / 10.36 LBS
	24oz ITEM NO. 8377 SIZE: Ø 7 x 1.5 in.	w/ PP LID COMPO 150 SETS / CTN. CTN. SIZE 561 x 182 x 495mm 1.78 CU.FT. / 0.05 CBM 7.50 KG / 16.53 LBS	w/ OPS LID COMPO 150 SETS / CTN. CTN. SIZE 561 x 182 x 470mm 1.70 CU.FT. / 0.05 CBM 5.9 KG / 13.01 LBS
	32oz ITEM NO. 8399 SIZE: Ø 7 x 2 in.	w/ PP LID COMPO 150 SETS / CTN. CTN. SIZE 561 x 182 x 515mm 1.86 CU.FT. / 0.05 CBM 8.0 KG / 17.64 LBS	w/ OPS LID COMPO 150 SETS / CTN. CTN. SIZE 561 x 182 x 485mm 1.75 CU.FT. / 0.05 CBM 6.5 KG / 14.33 LBS
	35oz ITEM NO. 8337 SIZE: Ø 8 x 2 in.	w/ PP LID COMPO 150 SETS / CTN. CTN. SIZE 656 x 215 x 490mm 2.44 CU.FT. / 0.07 CBM 10.4 KG / 22.93 LBS	w/ OPS LID COMPO 150 SETS / CTN. CTN. SIZE 656 x 224 x 506mm 2.62 CU.FT. / 0.07 CBM 8.2 KG / 18.08 LBS
	48oz ITEM NO. 9999 SIZE: Ø 9 x 2 in.	w/ PP LID COMPO 150 SETS / CTN. CTN. SIZE 716 x 242 x 515mm 3.15 CU.FT. / 0.09 CBM 11.5 KG / 25.35 LBS	
	39oz 3 Comp. ITEM NO. 9333 SIZE: Ø 9 x 2 in.	w/ PP LID COMPO 150 SETS / CTN. CTN. SIZE 716 x 242 x 550mm 3.36 CU.FT. / 0.10 CBM 13.5 KG / 29.76 LBS	

These containers are made from heavy duty PP, designed to stand up to high temperatures for food service applications, also safe for freezer storage. With their sturdy construction, these containers will keep your food securely and reliably. It is a great way for holding a variety of items and heating up food without the hassle of switching containers. It's perfect for hot foods, stews, sauces, soups, salads or refrigerated foods. Freezer & dishwasher safe, reusable & recyclable, BPA & CFC free.

RECTANGULAR TYPE COMBO PACK



12oz

ITEM NO. 8300

SIZE: 5.5 x 4.5 x 1.5 in.

w/ PP LID COMPO

150 SETS / CTN.

CTN. SIZE 382 x 158 x 497mm

1.06 CU.FT. / 0.03 CBM

6.0 KG / 13.23 LBS

w/ OPS LID COMPO

150 SETS / CTN.

CTN. SIZE 382 x 158 x 400mm

0.85 CU.FT. / 0.02 CBM

4.4 KG / 9.70 LBS



16oz

ITEM NO. 8316

SIZE: 7.25 x 5 x 1.5 in.

w/ PP LID COMPO

150 SETS / CTN.

CTN. SIZE 418 x 212 x 436mm

1.36 CU.FT. / 0.04 CBM

7.8 KG / 17.20 LBS

w/ OPS LID COMPO

150 SETS / CTN.

CTN. SIZE 418 x 212 x 352mm

1.10 CU.FT. / 0.03 CBM

6.1 KG / 13.45 LBS



24oz

ITEM NO. 8322

SIZE: 7.25 x 5 x 2 in.

w/ PP LID COMPO

150 SETS / CTN.

CTN. SIZE 418 x 212 x 446mm

1.40 CU.FT. / 0.04 CBM

8.4 KG / 18.52 LBS

w/ OPS LID COMPO

150 SETS / CTN.

CTN. SIZE 418 x 212 x 397mm

1.24 CU.FT. / 0.04 CBM

6.5 KG / 14.33 LBS



26oz

ITEM NO. 8366

SIZE: 8.5 x 6 x 1.5 in.

w/ PP LID COMPO

150 SETS / CTN.

CTN. SIZE 485 x 233 x 435mm

1.74 CU.FT. / 0.05 CBM

9.0 KG / 19.84 LBS

w/ OPS LID COMPO

150 SETS / CTN.

CTN. SIZE 485 x 233 x 358mm

1.43 CU.FT. / 0.04 CBM

7.1 KG / 15.65 LBS



38oz

ITEM NO. 8388

SIZE: 8.5 x 6 x 2 in.

w/ PP LID COMPO

150 SETS / CTN.

CTN. SIZE 485 x 233 x 445mm

1.78 CU.FT. / 0.05 CBM

10.0 KG / 22.05 LBS

w/ OPS LID COMPO

150 SETS / CTN.

CTN. SIZE 485 x 233 x 358mm

1.43 CU.FT. / 0.04 CBM

7.6 KG / 16.76 LBS



SINGLE-WALL PAPER CUPS

VG single wall paper hot cups are made for serving hot beverages like coffee, tea, or cocoa.

Due to our state-of-the-art German forming machines, our cups feature a smooth rolled rim that ensures a leak proof lid fit.

We offered in a variety of sizes to suit multiple drinks and up to 6-color prints.



80mm
3.15" Dia.



8oz

PHC08W-D80
80 x 56 x 90
1,000 PCS / CTN.
CTN. SIZE (mm)
416 x 334 x 440
2.16 CU.FT.
0.06 CBM
9.1 KG / 20.0 LBS



8oz PP LID Closeable

PHCLID-D80B/W
80 x 23
1,000 PCS / CTN.
CTN. SIZE (mm)
410 x 310 x 340
1.53 CU.FT.
0.04 CBM
3.7 KG / 8.2 LBS

90mm
3.54" Dia.



10oz

PHC10W-D90
90 x 62 x 94
1,000 PCS / CTN.
CTN. SIZE (mm)
460 x 370 x 431
2.59 CU.FT.
0.07 CBM
10.3 KG / 22.8 LBS



12oz

PHC12W-D90
90 x 60 x 111
1,000 PCS / CTN.
CTN. SIZE (mm)
460 x 366 x 537
3.19 CU.FT.
0.09 CBM
11.5 KG / 25.4 LBS



16oz

PHC16W-D90
90 x 59 x 134
1,000 PCS / CTN.
CTN. SIZE (mm)
456 x 376 x 542
3.28 CU.FT.
0.09 CBM
13.9 KG / 30.6 LBS



20oz

PHC20W-D90
90 x 63 x 150
600 PCS / CTN.
CTN. SIZE (mm)
460 x 280 x 570
2.59 CU.FT.
0.07 CBM
9.8 KG / 21.7 LBS

All single and double wall paper cups share common lids



10-20oz PP LID

PHCLID-D90B/W
90 x 20
1,000 PCS / CTN.
CTN. SIZE (mm)
480 x 384 x 295
1.92 CU.FT.
0.06 CBM
5.1 KG / 11.3 LBS



DOUBLE-WALL PAPER CUPS

VG double-wall paper cup provides excellent heat insulation effects. The built-in thermal layer protects hands from heat and keeps drinks at appropriate temperature, and the outside of the cup comfortable to hold. The form-fitted sealing lid keeps beverages hotter longer and security.

Comfortable

Distinguishingly smooth outer wrap makes for a perfect surface to print clear and unambiguous artwork.

Built-in thermal layer makes the outer surface smoothly & comfortable handhold feel and tactile impression for customers.

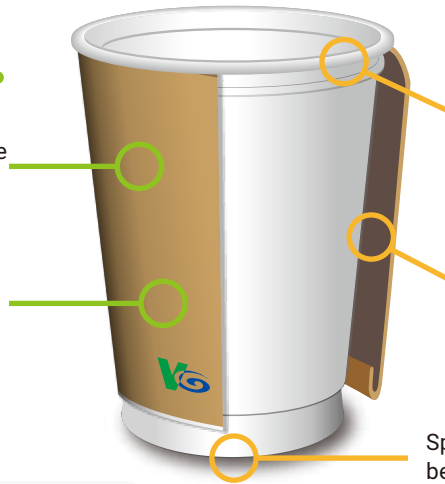

Sturdy & Durable

Our secure and form-fitting lid creates a superior sealed barrier which helps prevent leaks.

The inner air space helps conserve heat within the contents of the cup, as well as maintaining a cool to the touch outer wall.

Special wider bottom design provides better stability for placement.

MAXIMUM OUTSIDE SURFACE TEMPERATURE IN THE FIRST 3 MINUTES

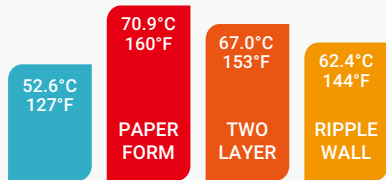

Hot water initial temperature 91°C / 196°F
ROOM TEMPERATURE : 25.4°C / 77.7°F

THE BEST CHOICE FOR THE SUSTAINABLE GROWTH OF THE PREMIUM BEVERAGE SEGMENT

Branded coffee companies & chains
Fast casual restaurants or C-stores
Hotels & lodging, airlines, and sports arenas



8oz

DWPHC08W-D80-V
80 x 53 x 96
500 PCS / CTN.
CTN. SIZE (mm)
416 x 336 x 512
2.53 CU.FT.
0.07 CBM
8.0 KG / 17.6 LBS



10oz

DWPHC10W-D90-V
90 x 60 x 96
500 PCS / CTN.
CTN. SIZE (mm)
466 x 376 x 450
2.78 CU.FT.
0.08 CBM
8.7 KG / 19.2 LBS



12oz

DWPHC12W-D90-V
90 x 61 x 114
500 PCS / CTN.
CTN. SIZE (mm)
466 x 376 x 536
3.32 CU.FT.
0.09 CBM
10.3 KG / 22.7 LBS



16oz

DWPHC16W-D90-V
90 x 60 x 139
500 PCS / CTN.
CTN. SIZE (mm)
466 x 376 x 590
3.65 CU.FT.
0.10 CBM
11.9 KG / 26.2 LBS



20oz

DWPHC20W-D90-V
90 x 56 x 164
500 PCS / CTN.
CTN. SIZE (mm)
467 x 476 x 720
5.54 CU.FT.
0.16 CBM
14.5 KG / 26.2 LBS

All single and double wall paper cups share common lids



8oz PP LID Closeable

PHCLID-D80B/W
80 x 23
1,000 PCS / CTN.
CTN. SIZE (mm)
410 x 310 x 340
1.51 CU.FT.
0.04 CBM
3.7 KG / 8.16 LBS



10-20oz PP LID

PHCLID-D90B/W
90 x 20
1,000 PCS / CTN.
CTN. SIZE (mm)
480 x 384 x 295
1.92 CU.FT.
0.06 CBM
5.1 KG / 11.3 LBS



PAPER COLD CUPS

Whatever your beverage of choice, soda, juice, mixed drink or iced tea, VG paper cold cups are your best option. The double poly coating provides superior water resistance and high-gloss graphics capabilities. The combination of fresh wood fiber paper board and our state-of-the-art German machinery make for strong cup sidewalls and smooth rims for a leak-resistant lid fit. We offered in a variety of sizes to suit multiple drinks and up to 6-color prints.



GENERIC / CUSTOM



7oz

PCC07W-D73
73 x 51 x 81
2,000 PCS / CTN.
CTN. SIZE (mm)
596 x 376 x 406
3.21 CU.FT. / 0.09 CBM
10.7 KG / 23.7 LBS



9oz

PCC09W-D75
75 x 52 x 97
2,000 PCS / CTN.
CTN. SIZE (mm)
636 x 406 x 412
3.76 CU.FT. / 0.11 CBM
13.9 KG / 30.7 LBS



12oz 90mm Dia.

PCC12W-D90
90 x 61 x 95
1,000 PCS / CTN.
CTN. SIZE (mm)
460 x 370 x 421
2.53 CU.FT. / 0.07 CBM
9.3 KG / 20.6 LBS



14oz

PCC14W-D90
90 x 59 x 112
1,000 PCS / CTN.
CTN. SIZE (mm)
460 x 366 x 520
3.09 CU.FT. / 0.09 CBM
10.6 KG / 23.3 LBS



16oz

PCC16W-D90
90 x 61 x 127
1,000 PCS / CTN.
CTN. SIZE (mm)
452 x 372 x 524
3.11 CU.FT. / 0.09 CBM
11.7 KG / 25.9 LBS



22oz

PCC22W-D90
90 x 61 x 168
1,000 PCS / CTN.
CTN. SIZE (mm)
460 x 370 x 612
3.68 CU.FT. / 0.10 CBM
14.8 KG / 32.7 LBS



32oz

PCC32W-D103
103 x 71 x 177
600 PCS / CTN.
CTN. SIZE (mm)
536 x 430 x 480
3.91 CU.FT. / 0.11 CBM
14.2 KG / 31.3 LBS



12-22oz PET LID

PCCLIDPET-D90
90 x 8
1,000 PCS / CTN.
CTN. SIZE (mm)
470 x 325 x 390
2.10 CU.FT. / 0.06 CBM
3.3 KG / 6.6 LBS



12-22oz PS LID

PCCLIDPS-F90
90 x 7
2,000 PCS / CTN.
CTN. SIZE (mm)
472 x 380 x 482
3.05 CU.FT. / 0.09 CBM
4.1 KG / 9.0 LBS



12-22oz PET LID

PCCLIDPET-F90
90 x 8
1,000 PCS / CTN.
CTN. SIZE (mm)
566 x 486 x 210
2.04 CU.FT. / 0.06 CBM
3.3 KG / 7.3 LBS



12-22oz PLA LID

PCCLIDPLA-F90
90 x 8
1,000 PCS / CTN.
CTN. SIZE (mm)
566 x 486 x 210
2.04 CU.FT. / 0.06 CBM
3.3 KG / 7.3 LBS



32oz PS LID

PCCLIDPS-F103
103 x 8
1,200 PCS / CTN.
CTN. SIZE (mm)
450 x 400 x 340
2.16 CU.FT. / 0.06 CBM
3.4 KG / 7.5 LBS



32oz PET LID

PCCLIDPET-F103
103 x 8
1,000 PCS / CTN.
CTN. SIZE (mm)
580 x 240 x 410
2.01 CU.FT. / 0.06 CBM
3.5 KG / 7.6 LBS



12 oz

PCHC12P-D90
 90 x 59 x 111
 1,000 PCS / CTN.
 CTN. SIZE (mm)
 460 x 366 x 537
 3.19 CU.FT.
 0.09 CBM
 10.5 KG / 23.2 LBS



16 oz

PCHC16P-D90
 90 x 59 x 134
 1,000 PCS / CTN.
 CTN. SIZE (mm)
 456 x 376 x 542
 3.28 CU.FT.
 0.09 CBM
 14.5 KG / 32.0 LBS



20 oz

PCHC20P-D90
 90 x 63 x 150
 600 PCS / CTN.
 CTN. SIZE (mm)
 460 x 280 x 570
 2.59 CU.FT.
 0.07 CBM
 9.8 KG / 21.7 LBS



22 oz

PCHC22P-D90
 90 x 61 x 167
 1,000 PCS / CTN.
 CTN. SIZE (mm)
 460 x 370 x 625
 3.76 CU.FT.
 0.11 CBM
 17.1 KG / 37.8 LBS

**PERFECT FOR
 HOT & COLD
 BEVERAGE**

These cups are protected with double-poly lining both inside and out. Ideal for both hot & cold drinks.

DOUBLE-POLY LINED SINGLE WALL PAPER CUPS

CUP HOLDERS

Material : PULP



2 CUP
 192 x 110 x 34mm
 600 PCS / CTN.
 CTN. SIZE (mm)
 585 x 410 x 228
 1.93 CU.FT.
 0.05 CBM
 13.5 KG / 29.8 LBS



4 CUP
 225 x 225 x 40mm
 300 PCS / CTN.
 CTN. SIZE (mm)
 443 x 443 x 331
 2.29 CU.FT.
 0.06 CBM
 13.5 KG / 29.8 LBS



CUP SLEEVES

Material : BROWN / WHITE KRAFT



FITS 8 OZ
 1,000 PCS / CTN.
 CTN. SIZE (mm)
 505 x 250 x 245
 1.09 CU.FT.
 0.03 CBM
 4.8 KG / 10.6 LBS



FITS 10~20 OZ
 1,000 PCS / CTN.
 CTN. SIZE (mm)
 560 x 262 x 278
 1.34 CU.FT.
 0.04 CBM
 6.2 KG / 13.7 LBS

PAPER BAGS

Material : BROWN / WHITE KRAFT

Available in White or Brown, can be printed upon for a variety of purposes and customized for different sizes.



WHITE 80gsm
 180 x 80 x 240
 400 PCS / CTN.
 CTN. SIZE (mm)
 390 x 270 x 340
 1.26 CU.FT.
 0.04 CBM
 9.2 KG / 20.3 LBS



WHITE 100gsm
 220 x 120 x 300
 400 PCS / CTN.
 CTN. SIZE (mm)
 510 x 320 x 370
 1.96 CU.FT.
 0.06 CBM
 12.4 KG / 27.3 LBS



BROWN 75gsm
 220 x 120 x 280
 400 PCS / CTN.
 CTN. SIZE (mm)
 510 x 320 x 370
 1.84 CU.FT.
 0.05 CBM
 12.2 KG / 26.9 LBS



BROWN 75gsm
 240 x 120 x 300
 400 PCS / CTN.
 CTN. SIZE (mm)
 510 x 320 x 370
 2.13 CU.FT.
 0.06 CBM
 13.0 KG / 28.7 LBS



BROWN 114gsm
 280 x 320 x 120
 300 PCS / CTN.
 CTN. SIZE (mm)
 590 x 340 x 300
 2.12 CU.FT.
 0.06 CBM
 15.0 KG / 33.1 LBS



STANDARD PAPER FOOD CONTAINERS



IDEAL FOR BOTH **HOT** & **COLD** FOODS - OATMEAL, SOUP, ICE CREAM, & YOGURT.

VG paper food containers can be used with hot soup or pasta but also for cold and even frozen desserts such as ice cream and yogurt. Double poly coating provides moisture-resistant and grease-proof that locks in flavor and freshness. Suitable for restaurants, delis & supermarkets, ice cream & frozen yogurt shops.

Various sizes ranging in white and up to 6-color custom print, each with a tight-fit PP flat lid or PET dome lid option.



4oz

YGTC04W-D75
75 x 62 x 47
1,000 PCS / CTN.
CTN. SIZE (mm)
386 x 312 x 416
1.77 CU.FT.
0.05 CBM
4.9 KG / 10.8 LBS



6oz

YGTC06W-D96
96 x 81 x 49
1,000 PCS / CTN.
CTN. SIZE (mm)
496 x 398 x 524
3.65 CU.FT.
0.10 CBM
8.3 KG / 18.3 LBS



8oz

YGTC08W-D95
95 x 73 x 61
1,000 PCS / CTN.
CTN. SIZE (mm)
496 x 398 x 380
2.65 CU.FT.
0.07 CBM
8.4 KG / 18.6 LBS



12oz

YGTC12W-D101
101 x 70 x 80
1,000 PCS / CTN.
CTN. SIZE (mm)
520 x 420 x 446
3.44 CU.FT.
0.10 CBM
9.5 KG / 21.0 LBS



16oz

YGTC16W-D112
102 x 90 x 84
1,000 PCS / CTN.
CTN. SIZE (mm)
570 x 458 x 502
4.63 CU.FT.
0.13 CBM
12.6 KG / 27.9 LBS



20oz

YGTC20W-D126
126 x 105 x 76
600 PCS / CTN.
CTN. SIZE (mm)
520 x 390 x 456
3.26 CU.FT.
0.09 CBM
8.6 KG / 18.9 LBS



20oz

YGTC20W-D142
142 x 115 x 65
600 PCS / CTN.
CTN. SIZE (mm)
570 x 434 x 582
5.08 CU.FT.
0.14 CBM
9.7 KG / 21.4 LBS



24oz

YGTC24W-D142
142 x 115 x 75
600 PCS / CTN.
CTN. SIZE (mm)
570 x 434 x 696
6.08 CU.FT.
0.17 CBM
10.8 KG / 23.8 LBS



30oz

YGTC30W-D142
142 x 112 x 84
600 PCS / CTN.
CTN. SIZE (mm)
570 x 434 x 601
5.25 CU.FT.
0.15 CBM
10.7 KG / 23.7 LBS

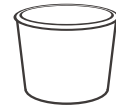

32oz

YGTC32W-D142
142 x 109 x 105
600 PCS / CTN.
CTN. SIZE (mm)
570 x 434 x 614
5.36 CU.FT.
0.15 CBM
12.4 KG / 27.3 LBS



8oz PP LID

YGTCCLID-F95
95 x 10
1,000 PCS / CTN.
CTN. SIZE (mm)
500 x 325 x 400
2.29 CU.FT.
0.06 CBM
3.5 KG / 7.7 LBS



6oz PP LID

DPPFCF16T-PPL
96 x 9
1,000 PCS / CTN.
CTN. SIZE (mm)
505 x 290 x 405
2.09 CU.FT.
0.06 CBM
3.5 KG / 7.7 LBS



12oz PP LID

YGTCCLID-F101
101 x 10
1,000 PCS / CTN.
CTN. SIZE (mm)
545 x 312 x 425
2.55 CU.FT.
0.07 CBM
4.0 KG / 8.8 LBS



16oz PP LID

YGTCCLID-F112
112 x 9
1,000 PCS / CTN.
CTN. SIZE (mm)
595 x 320 x 470
3.16 CU.FT.
0.09 CBM
4.5 KG / 9.9 LBS



20oz PP LID

YGTCCLID-F126
126 x 9
600 PCS / CTN.
CTN. SIZE (mm)
530 x 330 x 395
2.44 CU.FT.
0.07 CBM
4.0 KG / 8.8 LBS



20-32oz PP LID

YGTCCLID-F142
142 x 9
600 PCS / CTN.
CTN. SIZE (mm)
595 x 315 x 440
2.91 CU.FT.
0.08 CBM
4.5 KG / 9.9 LBS



PERFECT FOR
HOT & COLD
FOODS

HEAVY WEIGHT PAPER FOOD CONTAINERS

VG heavy weight paper food containers are perfect fit for both hot and cold applications.

Made with high quality paperboard and double-sided poly coated for extra strength, make these containers more rigid, durable, and versatile.

Ideal for hot take-out items such as soup or for storing ice cream in the freezer. Great for delis, salad bars, ice cream and frozen yogurt shops, fairs and more.





IDEAL FOR BOTH
HOT & COLD FOODS
 - OATMEAL, SOUP,
 ICE CREAM, & YOGURT.

Available in 8, 12, 16 Tall
 to 32 oz and come with
 a tight-fit vented PP flat lid.
 8, 12 & 16 Tall share one lid
 to reduce storage space
 and inventory cost.

Offered in white and
 up to 6-color print.



8oz
 DPPFCW08-B
 96 x 79 x 61
 1,000 PCS / CTN.
 CTN. SIZE (mm)
 496 x 398 x 432
 3.01 CU.FT.
 0.09 CBM
 10.2 KG / 22.5 LBS



12oz
 DPPFCW12-B
 96 x 77 x 73
 1,000 PCS / CTN.
 CTN. SIZE (mm)
 496 x 398 x 446
 3.11 CU.FT.
 0.09 CBM
 11.2 KG / 24.7 LBS

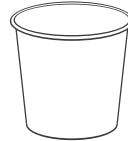

16oz Tall
 DPPFCW16T-B
 96 x 71 x 100
 1,000 PCS / CTN.
 CTN. SIZE (mm)
 496 x 398 x 476
 3.32 CU.FT.
 0.09 CBM
 13.4 KG / 29.5 LBS

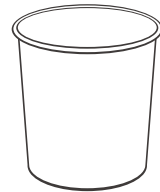

32oz
 DPPFCW32-B
 115 x 86 x 136
 500 PCS / CTN.
 CTN. SIZE (mm)
 596 x 466 x 378
 3.71 CU.FT.
 0.10 CBM
 11.0 KG / 24.2 LBS



8-12-16oz PP LID
 DPPFCF16T-PPL
 96 x 9
 1,000 PCS / CTN.
 CTN. SIZE (mm)
 505 x 290 x 405
 2.09 CU.FT.
 0.06 CBM
 3.5 KG / 7.7 LBS

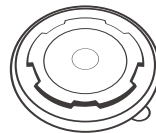

32oz PP LID
 DPPFCF32-PPL
 115 x 9
 500 PCS / CTN.
 CTN. SIZE (mm)
 600 x 310 x 245
 1.61 CU.FT.
 0.05 CBM
 2.5 KG / 5.5 LBS



SQUARE KRAFT PAPER FOOD BOX



VG square kraft paper food box with recyclable double PE coating paper is suitable for a variety of cold and hot foods applications. The square design and anti-fog PET lid create clean and space-saving look for displaying at supermarkets, food shops, grab and go stores.

Durability



The double PE coating makes the kraft paper food box waterproof and anti-grease.

Displayable



The anti-fog clear lid and square design provide the food visibility, freshness for display and food delivery security.

Multipurpose



Perfect for daily use, outdoor picnic, family party, travel etc.

Multiple sizes



Ranging from 240ml to 1920ml, it is suitable for salad, sandwiches, steak, spaghetti etc.

Recyclable



The square kraft paper food box is 100% recyclable.



5" 240ml

G0240
127 x 127 x 25
600 PCS / CTN.
CTN. SIZE (mm)
410 x 275 x 450
1.79 CU.FT.
0.05 CBM
5.3 KG / 11.8 LBS

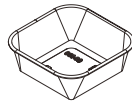

5" 480ml

G0480
127 x 127 x 45
600 PCS / CTN.
CTN. SIZE (mm)
410 x 275 x 455
1.81 CU.FT.
0.05 CBM
7.2 KG / 15.9 LBS

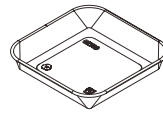

7" 720ml

G0720
178 x 178 x 31
300 PCS / CTN.
CTN. SIZE (mm)
562 x 375 x 275
2.05 CU.FT.
0.06 CBM
5.4 KG / 12.0 LBS

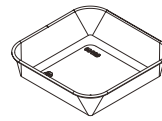

7" 960ml

G0960
178 x 178 x 42
300 PCS / CTN.
CTN. SIZE (mm)
562 x 375 x 295
2.19 CU.FT.
0.06 CBM
7.0 KG / 15.4 LBS

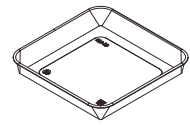

9" 1440ml

G1440
228 x 228 x 34
300 PCS / CTN.
CTN. SIZE (mm)
485 x 485 x 380
3.16 CU.FT.
0.09 CBM
9.6 KG / 21.1 LBS

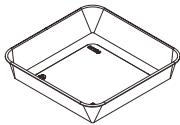

9" 1920ml

G1920
228 x 228 x 47
300 PCS / CTN.
CTN. SIZE (mm)
485 x 485 x 400
3.32 CU.FT.
0.09 CBM
10.6 KG / 23.3 LBS

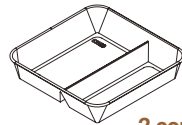

9" 690ml/460ml

G1800
228 x 228 x 47
300 PCS / CTN.
CTN. SIZE (mm)
485 x 485 x 475
3.94 CU.FT.
0.11 CBM
11.8 KG / 26.1 LBS

2 comp.



5" Lid

GL05
131 x 131 x 24
600 PCS / CTN.
CTN. SIZE (mm)
560 x 265 x 415
2.17 CU.FT.
0.06 CBM
5.6 KG / 12.3 LBS

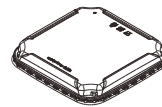

7" Lid

GL07
183 x 183 x 24
300 PCS / CTN.
CTN. SIZE (mm)
560 x 280 x 358
2.13 CU.FT.
0.06 CBM
5.1 KG / 11.3 LBS

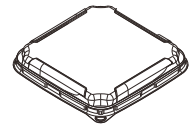

9" Lid

GL09
236 x 236 x 24
300 PCS / CTN.
CTN. SIZE (mm)
495 x 440 x 495
3.81 CU.FT.
0.11 CBM
8.9 KG / 19.6 LBS



CUSTOM PRINTING

GET YOUR MESSAGE DIRECTLY INTO THE HANDS OF YOUR CUSTOMERS.



**EASILY & EFFECTIVELY
PROMOTE YOUR BUSINESS**

Custom printing is the perfect solution to build your brand image and grow market awareness. It allows you to cost effectively advertise your company's brand - products, style and values - and provides a point of distinction for your brand in an otherwise saturated market. It is a portable billboard for your business right in your customers hands. It's an advantage that what we like to call "Brand In Hand".

Customize all your foodservice disposables – paper hot and cold cups, paper food containers, plastic drink cups, plastic round containers and cup sleeves.

WE UNDERSTAND PRINTING



PRINTING APPLICATION

We have world-class printing equipment. For plastic cups and containers, we have four 6-color Van Dam UV offset printing machines. For paper cups and containers, we have 8-color FLEXO machine and four German printing machines that print up to 5-colors.

PRINTING SERVICE

We manage all design and print services in-house. We can recreate or modify your existing artwork or our designers can help you develop an entirely new brand concept. We can even create mock-ups so that you can see what the actual product will look like once artwork is finalized.

5 STEPS

SIMPLE & EASY!

WE'RE HERE TO HELP

WHATEVER YOUR PRINTING NEEDS

01

Choose the cup or container size(s) you need. We offer a wide range of sizes on paper cold cups, paper hot cups – single or double wall, paper food containers, PET drink cups, PET round deli containers and PLA drink cups.

02

Choose up to 6-colors for your plastic cups / containers, 5-colors for your paper cups and containers and up to 4-colors for your customized PLA drink cups and cup sleeves.

03

Send us your artwork as an AI (Adobe Illustrator), EPS (Encapsulated PostScript) or PDF file. If electronic artwork is not available, send a sample of your cup or container and we will recreate the artwork by hand.

04

Once you have perfected your design, we will produce a digital file of the artwork for you to review and approve. We can also create a mock-up, if needed, for a minimal charge.

05

The printing process begins once the digital artwork file and/or mock-up has been approved and purchase order has been received. Custom printed products will be produced and delivered within our stated normal lead times.

Our minimum order quantity for most custom prints is 50,000 pieces per sku.

ARTWORK REQUIREMENTS



FILE FORMAT ▶ .AI

- Shapes and fonts must be outlined.
- Font size must be at least 8 pt bold.
- Artwork elements must be in layers, not merged.
- All images embedded and must be at least 300 dpi or higher.
- Define all colors CMYK or PANTONE® Solid Coated / Uncoated Color Code.
- PANTONE® Solid Coated Colors can be used, but not all colors can be achieved.

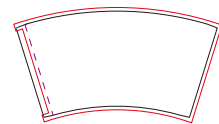

Available for all stock sizes.
Please feel free to contact us
for a template to get started.



If your artwork is designed by Photoshop or Corel Draw, please save it as a high resolution PDF, AI, or EPS file.

UNDERSTANDING PRINTING METHODS



CYAN MAGENTA YELLOW BLACK

4-COLOR PROCESS PRINTING

Process printing refers to a process that uses 4 colors - Cyan (C), Magenta (M), Yellow (Y) and Black (B) to reproduce a wide range of colors by mixing the colors together as they are printed. This is known as CMYK process printing or 4-color process printing. A wide range of colors can be created with just 4 color printing plates so the number of reproducible colors is much higher than four. PANTONE® color codes can be provided as a final color reference, but not all PANTONE® colors can be reproduced.

SPOT COLOR PRINTING



Spot color printing uses a color system of solid, pre-mixed colors, also known as PANTONE® colors. Spot colors are more accurate as you have already determined the color by its specific PANTONE® number. It is generally more economical if printing is kept to 3-colors or less.

Due to the use of food-grade inks, not all PANTONE® colors can be achieved. Also, spot colors are nearly impossible to replicate exactly on digital print devices such as color laser printers. Please note that the same color may appear differently on different raw materials.

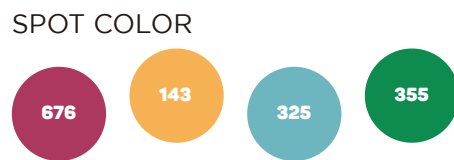
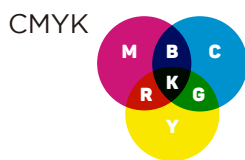
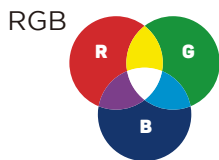

PRINTING INFORMATION & DISCLAIMERS

COLOR ACCURACY

When a PANTONE® color code is provided, finished products are expected to be within 2 PANTONE® colors, either up or down (refer to PANTONE® Solid color book). Due to food grade inks, not all PANTONE® color codes can be achieved, and any possible replacement is only at the manufacturer's discretion.

INK ODOR

As a result of printing with food grade inks, a degree of ink odor should be expected in all custom printed products. Any possible replacement is only at the manufacturer's discretion.

PRINT GAP

A ¼" gap is left between the leading edge of the design PET/PLA cups so that the design does not overlap.

MINIMUM & LEAD TIMES

- All stated minimums apply for each size and/or design ordered. Minimums are subject to change at any time. Due to the nature of custom printed products, there may be a +/- 10% over/under run (variance between amount ordered and amount produced).
- Lead times are estimated and are not guaranteed.

PLATE CHARGES

Plate charges will not be charged for reprint orders provided the existing plates are in good condition. If left unused, printing plates have a maximum life of 18 months. Customer will be notified if new plates will be necessary for their re-print orders and subsequently billed for the new plates.

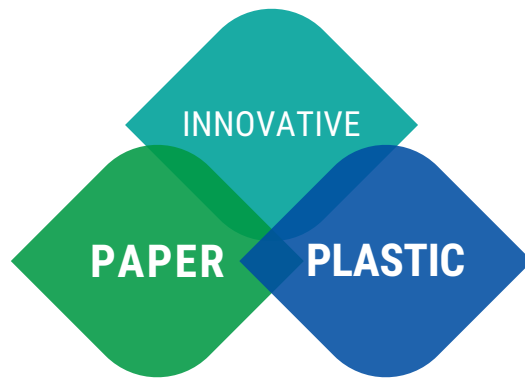

FULL LINE DISPOSABLE PACKAGING SOLUTIONS
TO MEET THE EVOLVING DEMANDS



No. 17, Lugong Rd., Lukang Township,
Changhua County 505, Taiwan R.O.C.

TEL: + 886 4 781 1589
FAX: + 886 4 781 2078

www.vigourpack.com

© VigourPak and Vigour Plastic all rights reserved.